

**Solutions for photovoltaic systems**



**THINK CONNECTED.**

# ProtectPlus. The OBO system kit for comprehensive protection of photovoltaic systems

---

It is our aim to provide a complete system for almost any electrical requirements in a photovoltaic system. This brochure contains our solutions for a permanently safe and quick installation.

---

**PROTECTPLUS**



How do I install external lightning protection in combination with a photovoltaic system? How do I maintain separation distances to the lightning protection system? What options do I have for strain relief of vertical cable routing? How do I best protect the inverter? How do I route cables in the area of emergency and escape routes?

In the Basic Principles section, we can provide the answer to a range of questions – with practical mounting solutions for sloping and flat roofs and field solutions.



## Contents

---

**External lightning protection**

---

**Surge protection systems**

---

**Equipotential bonding systems**

---

**Earthing systems**

---

**Cable routing**

---

**Construction fire protection**

---

**Directories**

**As the installation engineer of a PV system, you carry the responsibility. Not a problem with ProtectPlus.**



**“The overall responsibility for electrical safety is in the hands of the commissioner.”**

### **Photovoltaics working party**

The erection of a photovoltaic system often requires major intervention in the electrical infrastructure of a building. This is reflected in the wide range of standards and regulations to be complied with. The person erecting the system is liable for correct fulfilment for 30 years, and the requirements of the insurance company come on top of that.

---

**Please observe the appropriate local and statutory requirements.**

#### **Responsibility of the erection engineer**

Depending on the system type, the following standards must be complied with:

#### **Lightning protection**

- VDE 0185-305-1 to -4
- VDE 0185-305-3 suppl. sheet 5
- IEC 62305-1 to -4

#### **Surge protection**

- VDE 0100-433
- IEC 60364-4-44

#### **Low-voltage electrical installations**

- VDE 0100-534
- IEC 60634-5-534
- VDE 0100-410
- IEC 60634-4-41
- VDE 0100-443
- IEC 60634-4-44

#### **Requirements for solar PV power supply systems**

- VDE 0100-712
- IEC 60634-7-712

#### **Construction fire protection**

- DIN 4102



### **Responsibility of the operator**

Through the feed-in of the gained energy, almost every PV system is subject to the requirements for commercial use. For the system operator, this creates the obligation to give the system the proper maintenance, checking and repairs. These regular recurring checks of the electrical system components may only be carried out by an electrical technician.



**The specialist company installing a PV system is required by law to hand it over in perfect condition.**

## With ProtectPlus, photovoltaic systems can beat storms, snow, rain, cold, sun and heat for decades.

Throughout their lifespan, photovoltaic systems are exposed to huge loads. Wind and weather take their toll on all the components of the system and lightning and surge voltages pose a major risk to the inverter. ProtectPlus can provide comprehensive protection of the entire system against damaging environmental influences.



### Protection against direct lightning strikes

The enormous energy of lightning can destroy PV systems in the blink of an eye, risking the economic viability of the entire system. Long-term monitoring – for example by BLiDS (Siemens lightning and information service, <http://blids.de>) – document a continuous increase in lightning levels and lightning strikes.

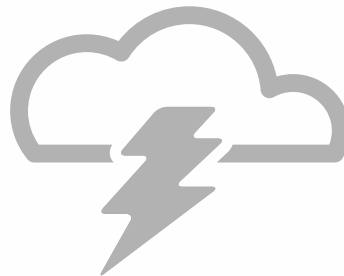

### Protection against surge voltage

On the alternating current side, the sensitive inverter is threatened by destructive surge voltages from switching operations and network couplings. Lightning strikes generate dangerous surge voltages in a radius of two kilometres. In the worst-case scenario, these voltage peaks are enough to damage the core of the system.

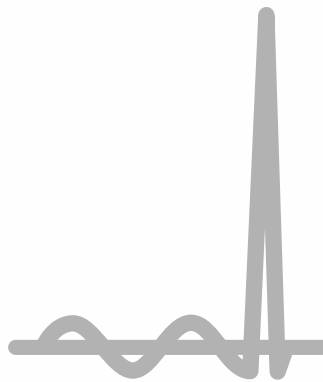



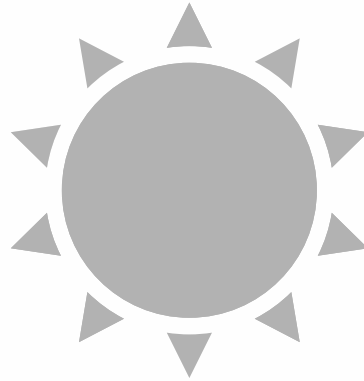
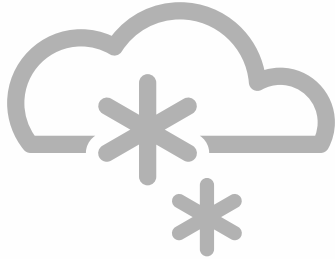
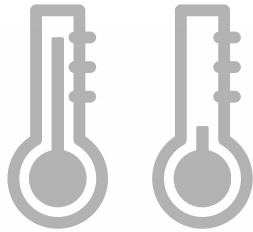

### **Protection against environmental factors**

Photovoltaic systems are suffering increasingly – meteorological observations show an increase in extreme weather conditions. Only a solidly executed installation can beat rain, snow, heat and cold throughout the lifespan of the system.



### **Protection against mechanical loads**

A PV system is exposed to different mechanical loads. Wind continuously batters all the outdoor system components, whereas snow places huge weights on the whole system. In the case of vertical cable routing, heavy loads occur, which must be supported using an appropriate strain relief.



### **Protection against the spread of fires**

Lightning protection for PV systems has various requirements: the spread of fires in the area of fire protection walls must be prevented, both outside and inside the building. In emergency and escape routes, the cable routing may not bring in any fire loads.

## Coordinated protection. The ProtectPlus system kit.

A well-thought-out system for the whole electrical infrastructure of a photovoltaic system – that's ProtectPlus. Different components provide comprehensive protection, which allows both the erection engineer and the system operator to sleep in peace.

# PROTECTPLUS



### External lightning protection systems

Lightning currents are intercepted and run safely to the earth with the following systems:

- Interception rods and interception masts
- Insulated lightning protection
- Insulated isCon® conductor
- Flat and round conductors
- Cable bracket
- Connection clamps and connection terminals



### Cable support systems

Quick-mounting, safe cable routing with:

- Cable trays
- Mesh cable trays
- Cable ladders
- Vertical ladders
- Suspended supports
- Wall and support brackets



### Earthing systems

Our products for perfect earthing:

- Flat and round conductors
- Connectors
- Connection terminals
- Earth entries
- Deep, ring and foundation earther
- Corrosion protection





**Equipotential bonding systems**

Equipotential bonding systems are the link between external lightning protection, surge protection and earthing. They are available in the following variants:

- For indoor use
- For outdoor use
- For industrial use



**Cable routing systems**

Tidy cable routing within the building can be achieved using

- Wall and ceiling ducts
- Cable and pipe fastening systems made of plastic and metal
- Screw-in and knock-in systems
- Rail systems



**Surge protection systems**

A product range for almost any application:

- Lightning arrester/combination arrester
- Surge protection for energy and data technology
- Complete system solutions, terminated in the housing
- Combination and surge voltage arresters for the photovoltaic DC side



**Fire protection systems**

Our fire protection systems consist of the following components:

- Insulation
- Weatherproof fire protection jacketing
- Systems for emergency and escape routes

## External lightning protection for sloping roof systems



*Sloping roof with PV and lightning protection systems*

### **Complete product range, decades of experience**

The inclusion of a photovoltaic system into the existing lightning protection concept of a building is often neglected during refitting work. This significantly increases the risk of considerable damage through a direct lightning strike.

For public buildings, for example, the LBO (state construction regulations) require a lightning protection system to protect people and provide protection against fires.

Our product range and our experience mean that we can offer the right solutions for almost any type of sloping roof. Amongst other things, it comprises:

- Interception rods
- Rod holders
- Ridge conductor holder
- Roof cable holder for ridge riles
- Roof cable holder for various roofing types
- Cable bracket
- Round and flat conductors

### **Four materials**

Our products are available in four different materials:

- Steel, hot-dip galvanised
- Copper
- Aluminium
- Stainless steel



*Conductor, connected with gutter clamp*





### **Separation distance**

According to DIN EN 62305, the PV system must be erected at a separation distance (s) from the parts of the lightning protection system. Usually, a safety distance of 0.5 m to 1 m is sufficient. Otherwise, if there is a lightning strike, the lightning current may arc into the photovoltaic system. Use of the isCon® cable always ensures the separation distance can always be maintained.

## External lightning protection for flat roof systems







*Flat roof with PV system and insulated isCon® cable*

**Lightning protection equipotential bonding system**

Various points should be observed when arresting the lightning current. Metallic components without a conductive connection into the building must be connected directly to the lightning protection. Active DC/AC cables and data systems are included in the equipotential bonding using suitable lightning current and surge arresters at the entry to the building. All metallic parts of a building and electrically powered equipment and their supply cable must be integrated into the lightning protection system.

**Separation distance**

Air-conditioning systems, electrical sensors and photovoltaic systems are examples for roof structures in which the separation distance must be maintained. This distance is required to avoid dangerous sparking and lightning components between both the external lightning protection system and the metallic building parts and electrical devices.

In particular, when PV systems are refitted, this is often not possible due to the construction situation. Here, the insulated isCon® cable can help. The ideal solution with which a separation distance of 0.75 m through the air and 1.5 m for solid matter can be maintained.



*Lightning protection equipotential bonding on the PV mounting system*

## External lightning protection for flat roof systems



*Insulated lightning protection and cable support system with TrayFix and stand-in flat roof area*

### **Air-termination systems**

External lightning protection protects the building against the effects of direct lightning strikes. Although that might sound simple in theory, in practice it can quickly become a complex task.

### **Existing roof structures**

Any existing roof structures, such as air-conditioning systems, require the same level of protection as the new photovoltaic system. OBO has various interception systems for this task.

- isFang interception rods up to a height of 8 m
- Insulated interception systems
- Interception rods made of steel, aluminium and copper
- Insulated isCon® cable



*Insulated lightning protection with GfK holder on pipeline*



Interception rod system with isCon® cable



Insulated lightning protection with GfK holder on cooling unit

### Shading

The position of the interception masts or interception rods should be chosen so that there is no shading of the PV modules. A core shadow can cause performance reductions of the whole string. An interception rod must be at least in the distance, of  $108 \times$  diameter of the lightning rod, away from the PV module.

### Distance from the interception systems, to avoid a core shadow

Diameter of the interception system (m)	Distance between the interception system and the PV module (m)
0.008	0.86
0.010	1.08
0.016	1.73





**PROTECTPLUS**

## Cable support systems

### Tough conditions

#### Simple installation

Cables outside the building are particularly exposed to the weather. Rain, snow, heat, UV radiation and wind continually attack the PV system. OBO cable systems combine the best possible protection with rapid mounting. Our product range comprises closed cable tray, wide span tray and mesh cable tray systems. Using clever details, such as the mounting adapter, you can fix mesh cable trays to the OBO FangFix stones in a single action. The covers are secured to the flat roof by tightening straps.

### Screening of cables

The passive screening of cables with OBO cable support systems with covers permits attenuation of up to 60 dB. This means that electronic system components are protected against electromagnetic interference, and economic losses through failure or damage are prevented.



*Attach the TrayFix mounting adapter and fixing plate, push it home and you're done*

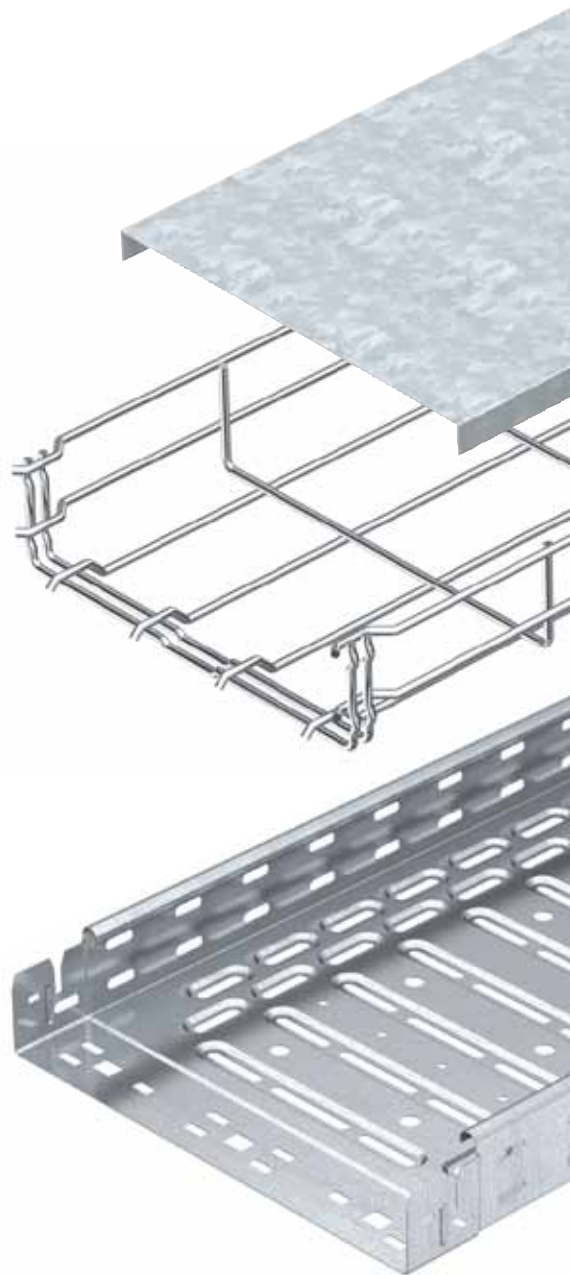





*Vertical ladder with strain relief*



## Cable support systems



*Cable routing with cable support system and plastic wall duct and surge protection*

### **Solid connections**

Tidy cable routing is at the heart of a PV system which can function for decades. Metallic cable trays and mesh cable trays protect the system against mechanical loads, both in indoor and outdoor areas.

### **Strain relief for vertical cable routing**

When cables are routed vertically, appropriate strain relief must be ensured. Our product range comprises vertical ladder systems with various profiles for direct wall mounting, for freestanding mounting or mounting on existing steel structures.



## Cable routing in the area of fire protection walls



*Protected bridging of the fire wall using a fire protection bandage*

### **Solutions for outdoor fire protection walls**

When cables are run over fire protection walls, serious errors are often made. Combustible cables may not bridge these areas without protection. The combination of our mesh cable tray and the weatherproof fire protection bandage ensures you are on the safe side – if there is a fire, the bandage foams up, preventing the fire from spreading.

### **Insulation in fire protection walls in buildings**

If an installation is run through a fire protection wall, then it should be closed with types of insulation in such a way as to prevent the spread of fire and smoke. OBO can offer different solutions to this task:

- Pyrosit® fire protection foam
- Fire protection cushion
- Fire protection mortar

The insulation is matched to different standard wall types



*In the area of a fire protection wall, the cover is replaced by a fire protection bandage*



*Insulation in a fire protection wall*

## Fire protection systems in emergency and escape routes



*Protected cable routing in the area of emergency and escape routes*

### **Systems for emergency and escape routes**

Within a building, cables often have to be routed through emergency and escape routes. Here, the installation engineer must deal with particularly strict regulations.

OBO systems offer you two methods of fulfilling these requirements. When mounted in false ceilings, the cables are run above a suspended fire protection ceiling. We can offer you various approved routing systems for this. The other option is cable routing with fire protection ducts made of fibreglass-reinforced light concrete for direct wall or ceiling mounting.



*Wall mounting of the fire protection duct*



## Cable routing systems protect cables and the reliability of the system.



### **Perfect protection in buildings**

Even in buildings, cables are subject to mechanical loads, which, in the worst-case scenario, can lead to the failure of the system.

Combination of the OBO products creates reliable protection of cabling, from the roof through to the inverter. Wall and ceiling ducts of different dimensions are complemented with appropriate fittings.

Plastic and metal cable and pipe fastening systems and clips protect small cable volumes and individual cables. In this way, you can protect the system against failure through torn or worn-through cables for decades to come.



*Metal pipe systems: the first choice for protection under tough conditions*



*Plastic pipe systems*



*Pre-marked openings to minimise condensation through temperature variations*

---

According to DIN VDE 0100-520 – Erection of heavy current systems (IEC 60364-5-52) for rated voltages of up to 1,000 V. “Measures must be taken to remove water, if water or water condensation can occur within cable systems”.

## Protection in every direction: surge protection systems



### All-round protection

There are always two sides to the surge protection of photovoltaic systems. On the direct current side (DC), there can be surge voltages from lightning strikes, whilst, on the alternating current side (AC), voltage peaks from the power and data network may damage the inverter. OBO surge protection reliably protects every side.

Existing data cables can be safely included in the equipotential bonding using protection devices.

### The complete product range

The OBO surge protection product range has a modular structure and can offer solutions for almost any application. It comprises:

- Lightning arrester
- Combination arrester
- Surge arrester

The pre-terminated photovoltaic system solutions for the most common requirements are particularly practical as they require only the minimum of installation work.

---

**Do you require special solutions, such as insulators or fuses?  
Please get in touch with us.**

**OBO Customer Service  
+49 (0)2373 89-1500  
E-mail: [info@obo.de](mailto:info@obo.de)**



*Insulated lightning protection and combination arrester on inverter*



*Surge protection on the AC PV distributor*





**Simply connect them.  
And that's it.**

**OBO photovoltaic system solutions**

# Solutions for field photovoltaic systems





Today, PV systems in the MW range are a key power supply component. This investment should be protected against theft, against risks from lightning and surge voltages and against damage and failures from incorrect cable routing. OBO offers solutions from external lightning protection systems through to proper cable routing with cable support systems.

## **PROTECTPLUS**





You do the planning. OBO can support you in the correct implementation of the system.



## Support in every phase of the project



### **Time is money**

Our customers in the field systems sector place great emphasis on competent advice in all phases of the project. The comprehensive, networked OBO product range ensures flawless, quick project processing.



---

**OBO Customer Service**  
**+49 (0)2373 89-1500**  
**E-mail: [info@obo.de](mailto:info@obo.de)**

# Planning aid, protective angle method

## Protective angle method for roof structures

You have protected the flat-roofed building correctly according to the standard VDE 0185-305 (IEC 62305). You must now protect all roof structures with interception rods. This involves observing the separating distance (s).

If the roof structure has a conductive continuation into the building (e.g. with a stainless steel pipe with a connection to the ventilation or air conditioning system), then the separating distance (s) must always be maintained. The interception rod must be erected at a certain distance from the building to be protected. This distance safely prevents arcing of the lightning current and dangerous spark creation.



$\alpha^\circ$  = lightning protection angle, s = separating distance

## Roof structures with an individual interception rod

The protective angle for lightning rods varies according to lightning protection class. You can find the protective angle (a) in the table for the most common interception rods of up to 2 m in length.

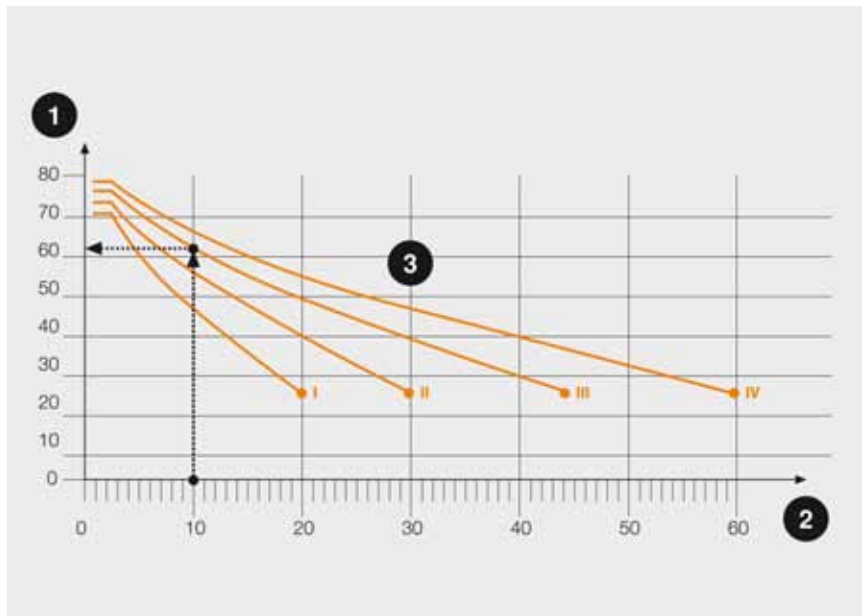

1 = lightning protection angle  $\alpha^\circ$ , 2 = roof-structure height h in m, 3 = lightning protection class I/II/III/IV

## Protective angle according to lightning protection class according to VDE 0185-305 (IEC 62305)

Lightning protection class	Protection angle $\alpha$ for interception rods to 2 m length
I	70°
II	72°
III	76°
IV	79°



## Planning aid, rolling sphere method



$p$  = penetration depth,  $R$  = radius of the lightning sphere,  $d$  = distance of the interception system



$$p = R - \sqrt{R^2 - \left(\frac{d}{2}\right)^2}$$

Formula for calculating the penetration depth ( $p$ )

### Roof structures with multiple interception rods

If you use several interception rods to protect an object, you must take into consideration the penetration depth between them. For a precise calculation, use the following formula:

### Penetration depth according to the lightning protection class according to VDE 0185-305 (IEC 62305)

Distance of interception system ( $d$ ) in m	Penetration depth Lightning protection class I lightning protection sphere: $R = 20$ m	Penetration depth Lightning protection class II lightning protection sphere: $R = 30$ m	Penetration depth Lightning protection class III lightning protection sphere: $R = 45$ m	Penetration depth Lightning protection class IV lightning protection sphere: $R = 60$ m
2	0.03	0.02	0.01	0.01
3	0.06	0.04	0.03	0.02
4	0.10	0.07	0.04	0.04
5	0.16	0.10	0.07	0.05
10	0.64	0.42	0.28	0.21
15	1.46	0.96	0.63	0.47
20	2.68	1.72	1.13	0.84

# Lightning protection equipotential bonding system and separation distance



Separation distance ( $s$ ) between the lightning protection system and cable support system

## Important measures

The following points must be taken into account in order to ensure comprehensive protection of the PV system:

- The local earthing (EBS) must be connected to the main equipotential bonding systems (MEBS).
- Equipotential bonding conductors must be routed closely and in parallel to the DC cables.
- Data cables must be included in the protection concept.

Table 1 provides an overview of the protective measures.

## Separation distance

According to DIN EN 62305, the lightning protection system must be erected at a separation distance ( $s$ ) from the parts of the PV system. Usually, a separation distance ( $s$ ) (= safety distance) of 0.5 m to 1 m is sufficient.

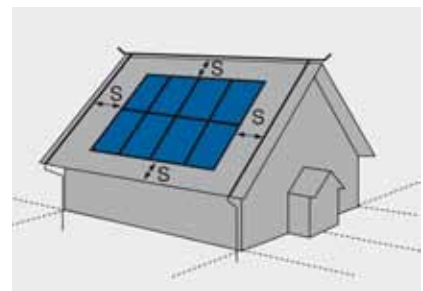

Separation distance ( $s$ ) between the PV and the lightning protection system

# Four steps to comprehensive protection

### Step 1:

#### Check the separation distance

If the required separation distance cannot be complied with, then the metallic parts must be interconnected to be able to carry lightning current.

### Step 2:

#### Check the protection measures

Example: measures for lightning protection equipotential bonding are used on the DC and AC side, e.g. lightning arrester (Type 1).

### Step 3:

#### Include data cables

Data cables must be included in the protection concept.







### Step 4:

#### Carrying out the equipotential bonding

Local equipotential bonding must be provided on the inverter.



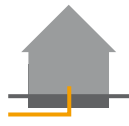

## Overview of protection measures









Initial situation	Measure	Separation distance according to DIN EN 62305 maintained	Equipotential bonding	Surge protection	Sample product picture
<ul style="list-style-type: none"> <li>External lightning protection system (according to DIN EN 0185-305)</li> </ul> 	Adapt the lightning protection system according to DIN EN 62305	Yes	min. 6 mm <sup>2</sup>	DC: Type 2	
				AC: Type 1	
	Adapt the lightning protection system according to DIN EN 62305	No	min. 16 mm <sup>2</sup>	DC: Type 1	
				AC: Type 1	
<ul style="list-style-type: none"> <li>No outside lightning protection system</li> <li>Earthing cable connection</li> </ul> 	Requirements' testing: LBO, Vds 2010, risk analysis	-	min. 6 mm <sup>2</sup>	DC: Type 2	
				AC: Type 2	







## DC surge protection, energy technology, type 2









Energy technology, protection of the DC side									
Initial situation	Max. DC voltage	Max. number of MPP per inverter	Max. number of strings per MPP	Connection (DC side)	Version	Type	Item no.	Product picture	
<ul style="list-style-type: none"> <li>No external lightning protection system</li> <li>Earthing cable connection</li> </ul> <p>The following is required:</p> <ul style="list-style-type: none"> <li>Surge protection, Type 2</li> <li>Lightning protection equipotential bonding 6 mm<sup>2</sup></li> </ul> 	600 V				<b>Complete block</b>	V20-C 3PH-600	<b>5094605</b>		
		1	1	MC 4 connector	System solution	VG-C DCPH-Y600	<b>5088670</b>		
	1,000 V					<b>Complete block</b>	V20-C 3PH-1000	<b>5094608</b>	
		1	1	MC 4 connector	System solution	VG-C DCPH-Y1000	<b>5088672</b>		
		1	4	Terminal	PC housing	VG-C DCPH1000-4K	<b>5088650</b>		
		1	4	Terminal	String fuse (+ pole), PC housing	VG-C DCPH1000-4S	<b>5088651</b>		
		1	6	Terminal	System solution	VG-C DCPH-MS1000	<b>5088691</b>		
		1	6	Terminal	String fuse (+ pole), PC housing	VG-C DCPH1000-6S	<b>5088652</b>		
		2	2	MC 4 connector	PC housing	VG-C DCPH1000-21	<b>5088646</b>		
		3	2	MC 4 connector	PC housing	VG-C DCPH1000-31	<b>5088648</b>		

## DC combination arrester; Type 1+2 and data protection devices

Energy technology, protection of the DC side									
Initial situation	Max. DC voltage	Max. number of MPP per inverter	Max. number of strings per MPP	Connection (DC side)	Version	Type	Item no.	Product picture	
<ul style="list-style-type: none"> <li>External lightning protection system (according to DIN EN 0185-305)</li> </ul> <p>The following is required:</p> <ul style="list-style-type: none"> <li>Lightning and surge protection, Type 1+2</li> <li>Lightning protection equipotential bonding 16 mm<sup>2</sup></li> </ul> 	600 V				<b>Complete block</b>	V50-B+V 3-PH600	<b>5093623</b>		
		1	1	MC 4 connector	System solution	VG-BC DCPH-Y600	<b>5088676</b>		
		1	5	Terminal	System solution	VG-BC DCPH-MS600	<b>5088693</b>		
		1	6	Terminal	Remote signalling	VG-BC DC-MSFS600	<b>5088695</b>		
	900 V					<b>Complete block</b>	V25-B+V 3-PH900	<b>5097447</b>	
		1	1	MC 4 connector	System solution	VG-BC DCPH-Y900	<b>5088678</b>		
		1	5	Terminal	System solution	VG-BC DCPH-MS900	<b>5088692</b>		
		1	6	Terminal	Remote signalling	VG-BC DC-MSFS900	<b>5088696</b>		

Data technology					
Initial situation	RJ 45	Terminal	Type	Item no.	Product picture
<ul style="list-style-type: none"> <li>No outside lightning protection system</li> <li>Earthing cable connection</li> </ul> 	●		ND-CAT6A/EA	<b>5081800</b>	
<ul style="list-style-type: none"> <li>External lightning protection system (according to DIN EN 0185-305)</li> </ul> 		●	FRD 24 HF	<b>5098575</b>	

# Selection aid, AC combination arrester and surge protection; Type 1+2, Type 2 and Type 3

		Installation location 1 Installation in the main distributor box / combined distributor Basic protection / Type 1, Type 2			
Initial situation	Building type	Description	Type	Item no.	Product picture
<ul style="list-style-type: none"> <li>No outside lightning protection system</li> <li>Earthing cable connection</li> </ul> 	Private building	TN-/TT Type 2 + 3 2.5 SU Secondary counter zone	V10 Compact	5093380	
			V10 Compact-AS, with acoustic remote signalling	5093391	
	Multiple dwelling/ industry, commerce	TN-/TT Type 2 4 SU Secondary counter zone	V20-C 3+NPE	5094656	
			V20-C 3+NPE+FS with remote signalling	5094765	
<ul style="list-style-type: none"> <li>External lightning protection system (according to DIN EN 0185-305)</li> </ul> 	Buildings of lightning protection classes III and IV (e.g. housing, offices and commercial buildings) Overhead power network	TN-/TT Type 1 + 2 4 SU Secondary counter zone	V50-B+C 3+NPE	5093654	
			V50-B+C 3+NPE+FS with remote signalling	5093662	
	Buildings of lightning protection classes I to IV (e.g. industry) Overhead power network	TN-C Type 1 6 SU Pre-metered or secondary counter zone	MCD 50-B 3	5096877	
			TN-S Type 1 8 SU Pre-metered or secondary counter zone	MCD 50-B 3+1	5096879









Installation location 2 Installation in the subdistributor Medium protection / Type 2 Only required if distance $\geq$			
Description	Type	Item no.	Product picture
TN-/TT Type 2 + 3 2.5 TE	V10 Compact	5093380	
	V10 Compact-AS, with acoustic remote signalling	5093391	
TN-/TT Type 2 4 TE	V20-C 3+NPE	5094656	
	V20-C 3+NPE+FS with remote signalling	5094765	
TN-/TT Type 2 4 TE	V20-C 3+NPE	5094656	
	V20-C 3+NPE+FS with remote signalling	5094765	
TN-/TT Type 2 4 TE	V20-C 3+NPE	5094656	
	V20-C 3+NPE+FS with remote signalling	5094765	

Installation location 3 Installation before the end device Fine protection Type 3			
Description	Type	Item no.	Product picture
Plug-in	FC-D	5092800	
	FC-TV-D	5092808	
	FC-SAT-D	5092816	
	FC-TAE-D	5092824	
	FC-ISDN-D	5092812	
	FC-RJ-D	5092828	
	CNS 3-D-D	5092701	
Fixed installation	ÜSM-A	5092451	
	KNS IS-D	5092523	
	ÜSS 45-O-RW	6117473	
Series installation in distributors	V10 Compact L1/L2/L3/N	5093380	
	VF230-AC/DC	5097650	
	VF230-AC-FS with remote signalling	5097858	



## External lightning protection

	Round conductor, aluminium	40
	FangFix Junior System	40
	Stand FangFix-System	40
	Interception rod holder	41
	Insulated spacer	41
	Cable bracket	41
	isCon© arrester system	44



# Interception and arrester systems



## Round conductor, aluminium

Type	Nominal size Ø mm	Cross-section mm <sup>2</sup>	Normal ring ca. m	Normal ring ca. kg	Weight kg/100 m	Item No.
<b>RD 8-ALU</b>	8	50	150	20	13,500	<b>5021 28 6</b>
<b>RD 8-ALU-T</b>	8	50	150	20	13,500	<b>5021 29 4</b>
<b>RD 10-ALU</b>	10	78	95	20	21,000	<b>5021 30 8</b>

**Al** Aluminium

price/100 m

- According to DIN EN 50164-2 (VDE 0185 Part 202)
- Meets the requirements of VDE 0185-305 (IEC 62305)
- RD 8/ALU: Semi-hard (E-ALMgSi0.5 corresponds to DIN 48801)
- RD 8/ALU-T: Twistable (E-ALMgSi0.5 corresponds to DIN 48801)
- RD 10/ALU: Pure aluminium (E-Al corresponds to DIN 48801)
- AL and ALMgSi may not be routed directly on, in or under the plaster, mortar or concrete nor underground

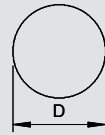

## Round conductor, stainless steel

Type	Nominal size Ø mm	Cross-section mm <sup>2</sup>	Normal ring ca. m	Normal ring ca. kg	Weight kg/100 m	Item No.
<b>RD 8-V2A</b>	8	50	125	50	40,000	<b>5021 23 5</b>
<b>RD 10-V2A</b>	10	78	80	50	63,000	<b>5021 23 9</b>
<b>RD 8-V4A</b>	8	50	125	50	40,000	<b>5021 64 4</b>
<b>RD 10-V4A</b>	10	78	80	50	63,000	<b>5021 64 7</b>

**V2A** Stainless steel, grade 304

**V4A** Stainless steel, grade 316 Ti

price/100 m

- According to DIN EN 50164-2 (VDE 0185 Part 202)
- Corresponds to the requirements of VDE 0185-305 (IEC 62305)
- RD 10-V4A for applications in the earth
- According to the foundation earthen standard DIN 18014, V4A is required in the earth

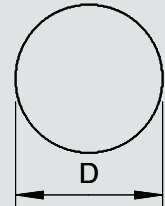

## FangFix Junior System

Type	Length mm	Nominal size Ø mm	Pack. pcs	Weight kg/100 pcs.	Item No.
<b>F-FIX-JUNIOR</b>	1000	10	10	32,000	<b>5403 30 8</b>

**Al** Aluminium

/pc.

- Incl. aluminium interception rod 1,000 mm long (Ø 10 mm)
- Quick mounting of the interception rod in the base using plug technology
- With Vario quick connector 249

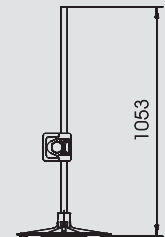

## Interception rod – tapered

Type	Length mm	Nominal size Ø mm	Pack. pcs	Weight kg/100 pcs.	Item No.
<b>101 VL1500</b>	1500	10/16	10	38,000	<b>5401 98 0</b>
<b>101 VL2000</b>	2000	10/16	10	55,000	<b>5401 98 3</b>
<b>101 VL2500</b>	2500	10/16	10	72,000	<b>5401 98 6</b>
<b>101 VL3000</b>	3000	10/16	10	88,000	<b>5401 98 9</b>
<b>101 VL3500</b>	3500	10/16	10	105,000	<b>5401 99 3</b>
<b>101 VL4000</b>	4000	10/16	10	120,000	<b>5401 99 5</b>

**Al** Aluminium

price/100 pc.

- Suitable for high wind loads
- Final metre tapered from Ø 16 mm to Ø 10 mm
- Suitable for FangFix stand system

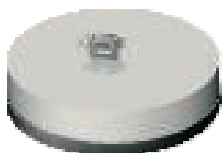
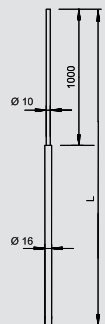

## Stand – FangFix system 16 kg

Type	Fit mm	Nominal size Ø mm	Pack. pcs	Weight kg/100 pcs.	Item No.
<b>F-FIX-16</b>	Rd 8	373	1	1732,500	<b>5403 20 0</b>

price/100 pc.

- System consists of FangFix stone with base and clamp
- FangFix clamp made of VA; lightning current tested with 100 kA (10/350)
- 16 kg stone of Ø 365 mm, high level of stability
- Quick and easy mounting of interception rod using anchors
- Concrete, frost-resistant
- The FangFix stone can be stacked

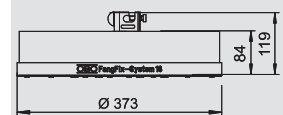

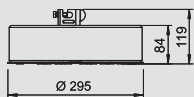

## Stand – FangFix system 10 kg



Type	Fit	Nominal size Ø	Pack.	Weight	Item No.
	mm	mm	pcs	kg/100 pcs.	
<b>F-FIX-10</b>	Rd 8	295	1	1058,000	<b>5403 10 3</b>

price/100 pc.



- System consists of FangFix stone with base and clamp
- FangFix clamp made of VA; lightning current tested with 100 kA (10/350)
- 10 kg stone of Ø 289 mm, high level of stability
- Quick and easy mounting of interception rod using anchors
- Concrete, frost-resistant
- The FangFix stone can be stacked

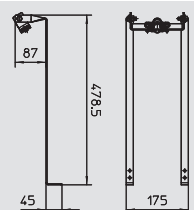

## Interception rod holder – sloping roof

Type	Pack.	Weight	Item No.
	pcs	kg/100 pcs.	
<b>SD-Fix</b>	1	81,000	<b>5403 33 5</b>

/pc.

Stand system: rod holder for sloping roofs, for simple, quick and secure fastening of Ø 16 mm interception rods.

- System consists of a bracket made of V2A stainless steel
- Quick and easy mounting
- Adjustable angle
- In the case of high interception rods (> 1 m), additional fastening with insulated spaces is necessary

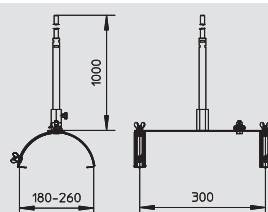

## Interception rod holder – ridge tiles

Type	Pack.	Weight	Item No.
	pcs	kg/100 pcs.	
<b>F-FIX-132</b>	1	62,000	<b>5403 33 0</b>
<b>F-Fix-132-300</b>	1	78,000	<b>5403 33 3</b>

/pc.

Rod holder for ridge tiles, for simple, quick and safe fastening of Ø 16 mm interception rods

- System consisting of holder made of V2A stainless steel and aluminium interception rod
- Quick and easy mounting thanks to pre-mounted air-termination rod
- Air-termination rod length: • Air-termination rod length: 1,000 mm
- Width adjustable between 180–260 mm
- Spacing of the ridge holders: 110 mm (5403330)
- Spacing of the ridge holders: 300 mm (5403333)

Application: To protect roof structures such as photovoltaic and TV/SAT systems.

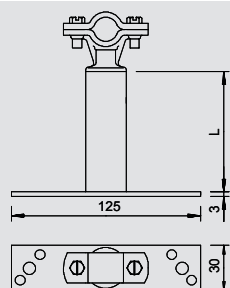

## Insulated spacer

Type	Length	Fit	Pack.	Weight	Item No.
	mm	mm	pcs	kg/100 pcs.	
<b>ISO-A-500</b>	500	Rd 16	15	36,000	<b>5408 80 6</b>
<b>ISO-A-800</b>	800	Rd 16	15	55,000	<b>5408 81 4</b>

Al Aluminium

/pc.

Insulated spacer for fastening interception rods Ø 16 mm at a separation distance to DIN VDE 0185-305-3.

- Mounting base with 4 connection holes Ø 6.5 mm and 2 connection holes Ø 8.5 mm
- With M10 bolts



## Insulated spacer – pipe mounting

Type	Pack.	Weight	Item No.
	pcs	kg/100 pcs.	
<b>ISAV1000R</b>	1	130,000	<b>5408 84 9</b>

GFK Fibre-glass-reinforced plastic

/pc.

Variable spacer for cables and interception rods to maintain the separation distance.

- Infinitely adjustable distance range (L = 550–1,000 mm)
- Made of fibre glass-reinforced plastic (km = 0.7)
- For pipe mounting (including 2 m tightening strap and tension jack)



# Interception and arrester systems



## Insulated spacer – wall mounting

Type	Pack.	Weight	Item No.
	pcs	kg/100 pcs.	
<b>ISAV1000W</b>	1	130,000	<b>5408 85 2</b>

**GFK** Fibre-glass-reinforced plastic /pc.

Variable spacer for cables and interception rods to maintain the separation distance.

- Infinitely adjustable distance range (L = 550–1,000 mm)
- Made of fibre glass-reinforced plastic (km = 0.7)
- For wall mounting with 10 4.2 mm fastening holes and 4 6.9 mm fastening holes

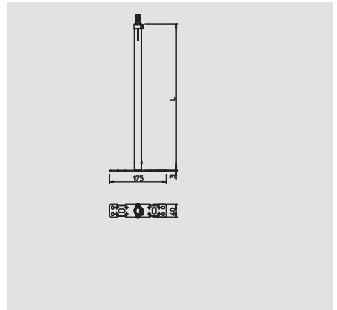

## Cable bracket

Type	Fit	Installation height	Pack.	Weight	Item No.
	mm	mm	pcs	kg/100 pcs.	
<b>177 20 M8</b>	Rd 8-10	20	50	1,050	<b>5207 44 4</b>

**PA** Polyamide price/100 pc.

- With female thread M8 or through hole  $\varnothing$  7 mm
- Weather and temperature-resistant from -35 °C to +90 °C

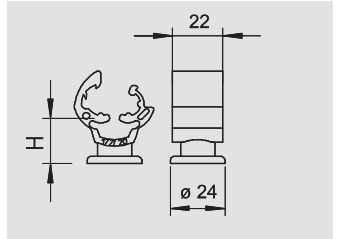

## Cable bracket

Type	Fit	Installation height	Pack.	Weight	Item No.
	mm	mm	pcs	kg/100 pcs.	
<b>177 20 VA M6</b>	Rd 8	20	50	2,500	<b>5207 33 9</b>

**V2A** Stainless steel, grade 304 price/100 pc.

- With female thread M6 or through hole  $\varnothing$  5 mm
- From stainless steel (V2A)
- Version -VK: copper-plated

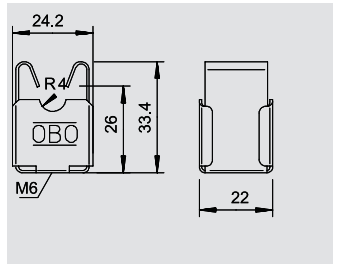

## Vario quick connector Alu

Type	Fit	Dimension A	Pack.	Weight	Item No.
	mm	mm	pcs	kg/100 pcs.	
<b>249 8-10 ALU</b>	Rd 8-10	44	30	6,600	<b>5311 51 9</b>

**Al** Aluminium price/100 pc.

- For T, cross and parallel connectors
- Quick installation using hexagonal bolt M10 x 30, high-grade stainless steel
- Conforms to the requirements according to DIN VDE 0185-305 (IEC 62305)

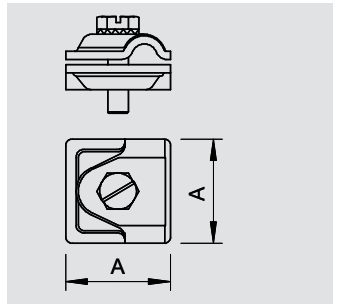

## Vario quick connector VA

Type	Fit	Dimension A	Material symbol	Pack.	Weight	Item No.
	mm	mm		pcs	kg/100 pcs.	
<b>249 8-10 VA</b>	Rd 8-10	40	V2A	50	10,700	<b>5311 55 1</b>

**V2A** Stainless steel, grade 304 price/100 pc.

- For T, cross and parallel connectors
- Quick installation using hexagonal bolt M10 x 30, high-grade stainless steel
- Conforms to the requirements according to DIN VDE 0185-305 (IEC 62305)

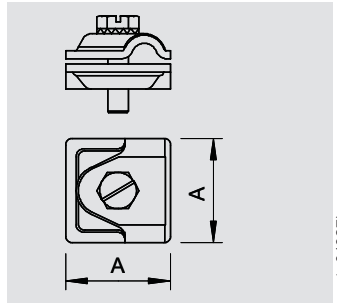

## Roof cable holder

Type	Fit	Pack.	Weight	Item No.
	mm	pcs	kg/100 pcs.	
<b>165 MBG-10</b>	Rd 10	12	106,000	<b>5218 67 5</b>
<b>165 MBG-8</b>	Rd 8	12	106,000	<b>5218 69 1</b>

**PE** Polyethylene price/100 pc.

- DIN 48829 Form B 1
- Closed form with bottom
- With double conductor holder
- Filling weight 1 kg (frost-resistant concrete)
- Sleeve from polyethylene, black, bottom polypropylene, black

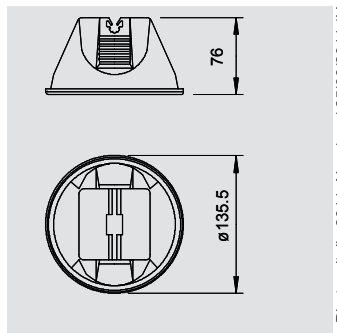



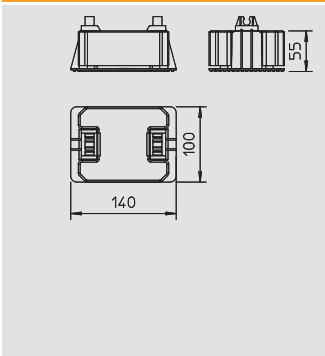

## Roof cable holder – recyclable

Type	Fit	Pack.	Weight	Item No.
	mm	pcs	kg/100 pcs.	
<b>165 R-8-10</b>	Rd 8-10	10	106,000	<b>5218 99 7</b>

**PE** Polyethylene price/100 pc.

165/R-8-10: Roof conductor holder for flat roofs

- For round conductor Rd 8 to 10
- With plastic mount, polyethylene, black
- Stone from frost-resistant concrete
- Weight 1 kg
- Stone separable into plastic and concrete (recyclable)

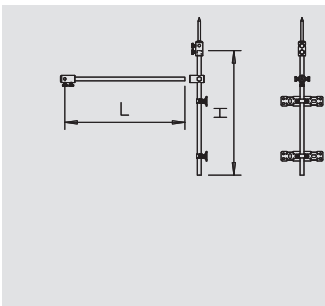

## Insulated lightning protection

Type	Dimension D	Dimension L	Dimension H	Product additional text 1	Pack.	Weight	Item No.
	Ø mm	mm	mm		pcs	kg/100 pcs.	
<b>101 3-ES-16</b>	16	750	1500	With M10 bolts	1	207,100	<b>5408 97 6</b>

/pc.

3-corner fastening: For an insulated interceptor unit at the separation distance, see mounting on walls and roof structures with two fastening plates. Seat for interception rods and round conductors of 8, 16 and 20 mm diameter.

With M10 bolts

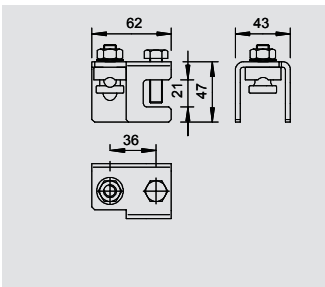

## Construction clamp

Type	Clamping area	Pack.	Weight	Item No.
	mm	pcs	kg/100 pcs.	
<b>5010 20 FT</b>	4-20	25	30,600	<b>5304 52 0</b>

**St** Steel **FT** Hot-dip galvanised price/100 pc.

- Round conductors can be installed vertical or transverse to structure
- For affixing to structures with a flange thickness of up to 20 mm
- Affixing to structures with a hexagonal bolt M10
- Conforms to the requirements according to DIN VDE 0185-305 (IEC 62305)

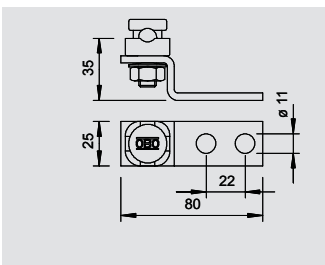

## Connection and end piece with connector

Type	Material symbol	Fit	Pack.	Weight	Item No.
		mm	pcs	kg/100 pcs.	
<b>5009</b>	St	Rd 8-10	50	14,500	<b>5304 97 0</b>

**St** Steel **F** Hot-dip galvanised price/100 pc.

- With 2 attaching holes Ø 11 mm
- Installed with connector (single-piece) type 5001 DIN-FT
- Conforms to the requirements according to DIN VDE 0185-305 (IEC 62305)

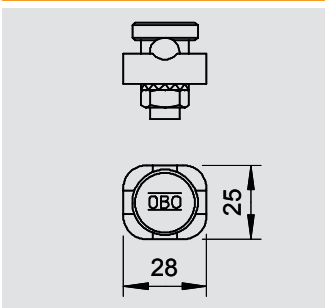

## Connectors

Type	Fit	Pack.	Weight	Item No.
	mm	pcs	kg/100 pcs.	
<b>5001 DIN-FT</b>	Rd 8-10	100	7,450	<b>5304 10 5</b>

**St** Steel **FT** Hot-dip galvanised price/100 pc.

- With fix contact clamping screw, nut and serrated washer
- With bore hole 10.2 mm
- With pre-mounted pressure piece, die-cast zinc
- Conforms to the requirements according to DIN VDE 0185-305 (IEC 62305)

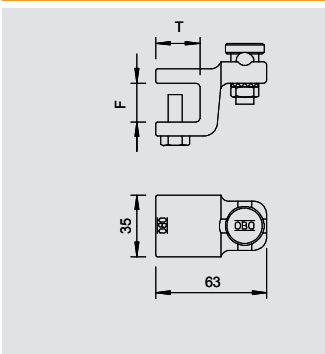

## Connection terminal for interception tip

Type	Fit	Dimension T	Dimension L	Clamping area	Pack.	Weight	Item No.
	mm	mm	mm	mm	pcs	kg/100 pcs.	
<b>5004 DIN-FT 12</b>	Rd 8-10	20	55	max. 12	25	18,730	<b>5304 40 7</b>
<b>5004 DIN-FT 20</b>	Rd 8-10	25	63	10-20	25	30,600	<b>5304 50 4</b>

**TG** Cast iron **FT** Hot-dip galvanised price/100 pc.

- Flange thickness to 12 or 10–20 mm
- With pre-mounted Fix-Kontakt clamping screw 5000
- 2 hexagonal bolts M8 x 20, screws made of hot galvanised steel,
- Terminal block made of malleable iron, hot galvanised
- Mounting of the round conductors either vertical or transverse to structure
- Corresponds to the requirements of DIN VDE 0185-305-3



# Interception and arrester systems



## isCon® arrester

Type	Colour	Cross-section mm <sup>2</sup>	Nominal size mm	Normal ring ca. m	Pack. m	Weight kg/100 m	Item No.
isCon 750 SW	Black	35	23	25	25	205,400	5408 00 2
isCon 750 SW	Black	35	23	100	100	103,400	5408 00 4

price/100 m

Surface discharge-free and high voltage-resistant insulated arrester to maintain the separation distance according to IEC 62305.  
Equivalent separation spacing  $s \leq 0.75$  m in the air.

Please refer to the mounting instructions for information on routing the OBO isCon® cable.

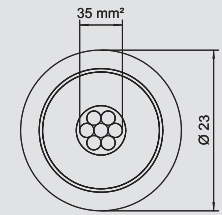

## isCon® insulation removal pliers

Type	Pack. pcs	Weight kg/100 pcs.	Item No.
isCon stripper	1	138,000	5408 00 9

/pc.

Pliers to remove the insulation of the OBO isCon® cable.



## isCon® connection element

Type	Dimension D Ø mm	Fit mm	Pack. pcs	Weight kg/100 pcs.	Item No.
isCon connect	23	10	2	21,500	5408 02 2

V2A Stainless steel, grade 304

/pc.

Screw-on termination of the connection for the isCon® cable.  
Including heat-shrinkable sleeve and screw lock.

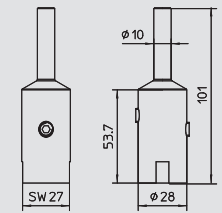

## isCon® potential connection

Type	Fit mm	Pack. pcs	Weight kg/100 pcs.	Item No.
isCon PAE	Ø 17-25mm	2	36,500	5408 03 6

V2A Stainless steel, grade 304

/pc.

Potential control to avoid surface discharges on the isCon® cable. Installation takes place after the first 1.5 metres.

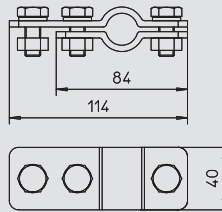

## isCon® VA cable bracket

Type	Dimension D Ø mm	Pack. pcs	Weight kg/100 pcs.	Item No.
isCon H VA	23	50	2,850	5408 05 6

V2A Stainless steel, grade 304

/pc.

Cable brackets for isCon® cable for mounting on roof/wall structures.

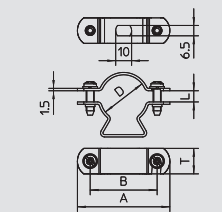

## isCon® flat roof cable holder

Type	Fit mm	Colour	Pack. pcs	Weight kg/100 pcs.	Item No.
165 MBG UH	Rd 8	Black	25	0,280	5218 88 2

PP Polypropylene

/pc.

Universal adapter with drillhole Ø 2.5 mm e.g. for OBO Golden Sprint screw, type 4758 4 x L (L = depending on application), for fastening to 165/MBG.

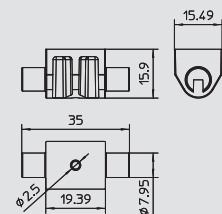

## isCon® M-Quick cable bracket PA

Type	Clamping range D mm	Pull-out value N	Colour	Shipping box pcs	Pack. pcs	Weight kg/100 pcs.	Item No.
M-Quick M25 SW	20-25	50	Jet black	600	50	0,930	2153 78 7

PA Polyamide

price/100 pc.

Multi-quick metric.  
Simple fastening.  
Secure locking.  
Radial arrangement.  
Simplified storage.  
Universally applicable.

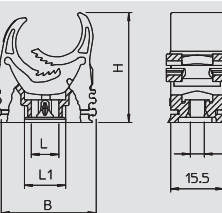

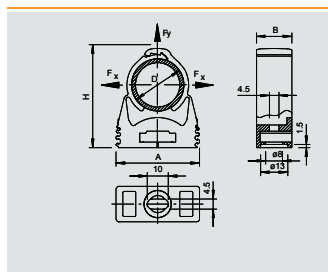

## isCon® Star-Quick clip



Type	Size	Clamping range D mm	Breaking load kN	Colour	Shipping box pcs	Pack. pcs	Weight kg/100 pcs.	Item No.
<b>SQ-20 SW</b>	—	19,5-23,5	0,8	Jet black	600	50	0,848	<b>2146 16 4</b>

**PP** Polypropylene price/100 pc.

Cable brackets for isCon® cables for mounting on the building structure. Can also be used in the first 1.5 m.

Can be arranged next to each other and are made from a UV and weather-resistant polyamide.

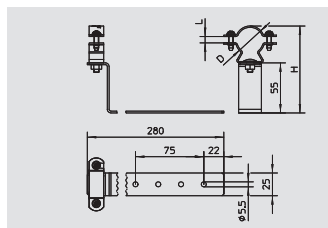

## isCon® VA roof cable holder, sloping roof

Type	Installation height mm	Dimension D Ø mm	Pack. pcs	Weight kg/100 pcs.	Item No.
<b>isCon H280 VA</b>	55	23	25	16,100	<b>5408 04 7</b>

**V2A** Stainless steel, grade 304

To route the isCon® cable on pitched roofs.

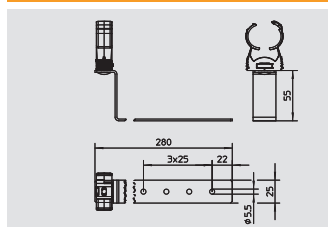

## isCon® PA roof cable holder, sloping roof

Type	Dimension	Dimension D Ø mm	Pack. pcs	Weight kg/100 pcs.	Item No.
<b>isCon H280 PA</b>	280mm	23	25	13,950	<b>5408 04 9</b>

**PA** Polyamide

To route the isCon® cable on pitched roofs.

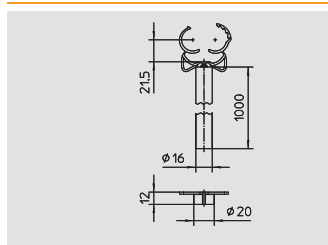

## isCon® spacer

Type	Clamping range D mm	Pack. pcs	Weight kg/100 pcs.	Item No.
<b>isCon DH</b>	23-26	2	41,400	<b>5408 04 3</b>

**GFK** Fibre-glass-reinforced plastic









For stand-off installation of the isCon® cable in the area of the connection. Incl. reducing sleeve for mounting on FangFix concrete block 10 Kg.







## Surge protection systems

	Lightning arrester	Type 1, energy technology AC	48
	Combination arrester	Type 1+2, energy technology AC	49
	Surge arrester	Type 2, energy technology AC	50
	Surge arrester	Data technology	51
	Lightning current and surge arrester	Type 1+2, photovoltaics	52
	Surge arrester	Type 2, photovoltaics	54
	Photovoltaic system solution	Connection with MC4 connector	60
		Connection with terminals	58
		Connection with MC4 connector with 2 / 3 MPP	57

# Lightning arrester for AC energy technology

230/400 V System  
 Type 1  
 LPZ 0→2  
  

Combination arrester, surge arrester, Type 1

- Protection level < 1.3 kV allows device protection
- For lightning protection equipotential bonding to VDE 0185-305 (IEC 62305)
- Lightning current arresting capacity to 50 kA (10/350) per pole and up to 150 kA (10/350) in total
- Line following current quenching 25 kA Ipeak, arrester backup fuse to 500 A gL/gG
- Suitable for use in pre-meter area according to the VDEW directive
- Encapsulated, non-extinguishing spark gap arrester for use in distributor housings

Application: Industrial systems and buildings with external lightning protection of the highest class I to IV.



## Lightning arrester for AC energy technology

Type	Highest continuous voltage V	Version	Pack. pcs	Weight kg/100 pcs.	Item No.
<b>MCD 50-B 3</b>	255	3-pole	1	117,000	<b>5096 87 7</b>

/pc.

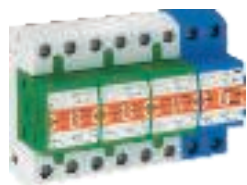
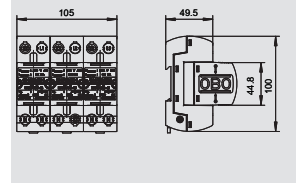

## Lightning arrester for AC energy technology

Type	Highest continuous voltage V	Version	Pack. pcs	Weight kg/100 pcs.	Item No.
<b>MCD 50-B 3+1</b>	255	3 + NPE	1	168,000	<b>5096 87 9</b>

/pc.

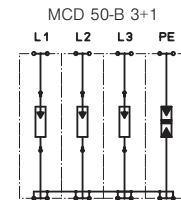
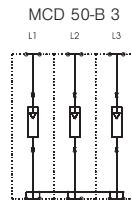
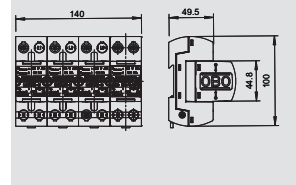

Nominal voltage	V	230 V	230 V
SPD to EN 61643-11		Type 1	Type 1
SPD to IEC 61643-1		class I	class I
LPZ		0→2	0→2
Lightning impulse current (10/350)	kA	50 kA	50 kA
Lightning impulse current (10/350) [total]	kA	150 kA	125 kA
Nominal discharge surge current (8/20)	kA	50 kA	50 kA
Arrester surge current (8/20) [total]	kA	150 kA	125 kA
Voltage protection level	kV	1,3 kV	1,3 kV
Response time	ns	<100 ns	<100 ns
Follow current quenching capacity Ipeak	kA	25 kA	25 kA
Maximum back-up fuse	A	500 A	500 A
Temperature range	ø °C	-40 - +85 °C	-40 - +85 °C
Division unit TE (17.5 mm)		6	8
Protection rating		IP20	IP20
Connection cross-section, rigid	mm <sup>2</sup>	10 - 50 mm <sup>2</sup>	10 - 50 mm <sup>2</sup>
Connection cross-section, multi-wire	mm <sup>2</sup>	10 - 35 mm <sup>2</sup>	10 - 35 mm <sup>2</sup>
Connection cross-section, flexible	mm <sup>2</sup>	10 - 25 mm <sup>2</sup>	10 - 25 mm <sup>2</sup>
<b>Item No.</b>		<b>5096 87 7</b>	<b>5096 87 9</b>



# Combination arrester for AC energy technology

Combination arrester, lightning current and surge arrester, Type 1+2



- For lightning protection equipotential bonding to VDE 0185-305 (IEC 62305)
- Lightning current arresting capacity 12.5 kA (10/350) per pole and up to 50 kA (10/350) in total
- Arrester, plug-in, with dynamic cut-off unit and visual function display
- Encapsulated, non-extinguishing zinc oxide varistor arrester for use in distributor housings

Application: Residential building with external lightning protection of Class III and IV.

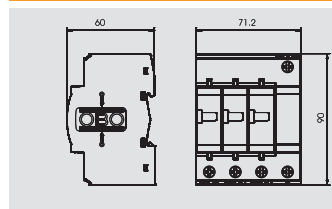

## Lightning current and surge arrester for AC energy technology

Type	Highest continuous voltage	Version	Pack.	Weight	Item No.
			pcs	kg/100 pcs.	
V50-B+C 1+NPE	280	1 + NPE	1	31,300	5093 65 3
V50-B+C 3+NPE	280	3+NPE	1	55,000	5093 65 4

/pc.

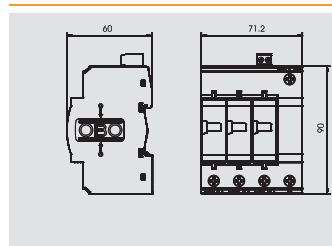

## Lightning current and surge arrester for AC energy technology with FS

Type	Highest continuous voltage	Version	Pack.	Weight	Item No.
			pcs	kg/100 pcs.	
V50-B+C 1+NPE+FS	280	1+NPE with FS	1	26,100	5093 66 1
V50-B+C 3+NPE+FS	280	3+NPE with FS	1	55,000	5093 66 2

/pc.



V50-B+C 1+NPE

V50-B+C 3+NPE

V50-B+C 1+NPE+FS

V50-B+C 3+NPE+FS

Nominal voltage	V	230 V	230 V	230 V	230 V
SPD to EN 61643-11		Type 1+2	Type 1+2	Type 1+2	Type 1+2
SPD to IEC 61643-1		class I+II	class I+II	class I+II	class I+II
LPZ		0→2	0→2	0→2	0→2
Lightning impulse current (10/350)	kA	12,5 kA	12,5 kA	12,5 kA	12,5 kA
Lightning impulse current (10/350) [total]	kA	25 kA	50 kA	25 kA	50 kA
Nominal discharge surge current (8/20)	kA	30 kA	30 kA	30 kA	30 kA
Arrester surge current (8/20) [total]	kA	50 kA	50 kA	50 kA	50 kA
Maximum discharge current	kA	50 kA	50 kA	50 kA	50 kA
Voltage protection level	kV	< 1,3 kV	< 1,3 kV	< 1,3 kV	< 1,3 kV
Response time	ns	<25 ns	<25 ns	<25 ns	<25 ns
Maximum back-up fuse	A	125 A	125 A	125 A	125 A
Temperature range	θ °C	-40 - +80 °C	-40 - +80 °C	-40 - +80 °C	-40 - +80 °C
Division unit TE (17,5 mm)		2	4	2	4
Protection rating		IP20	IP20	IP20	IP20
Connection cross-section, rigid	mm <sup>2</sup>	2,5 - 35 mm <sup>2</sup>	2,5 - 35 mm <sup>2</sup>	2,5 - 35 mm <sup>2</sup>	2,5 - 35 mm <sup>2</sup>
Connection cross-section, multi-wire	mm <sup>2</sup>	2,5 - 35 mm <sup>2</sup>	2,5 - 35 mm <sup>2</sup>	2,5 - 35 mm <sup>2</sup>	2,5 - 35 mm <sup>2</sup>
Connection cross-section, flexible	mm <sup>2</sup>	2,5 - 25 mm <sup>2</sup>	2,5 - 25 mm <sup>2</sup>	2,5 - 25 mm <sup>2</sup>	2,5 - 25 mm <sup>2</sup>
<b>Item No.</b>		<b>5093 65 3</b>	<b>5093 65 4</b>	<b>5093 66 1</b>	<b>5093 66 2</b>

12 LPA Lösungskatalog Photovoltaik\_2011\_Neu / en / 25/08/2011 (LLEExport\_01327)

# Surge arrester for AC energy technology

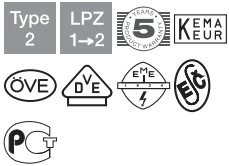

Surge arrester, Type 2, 280 V

- VDE-tested
- For surge voltage protection equipotential bonding to VDE 0100-443 (IEC 60364-4-44)
- Arresting capacity to 40 kA (8/20) per pin
- Arrester, connectable with dynamic cut-off unit and visual function display
- Encapsulated, non-extinguishing zinc oxide varistor arrester for use in distributor housings
- Base with multiple connection terminals

Application: Equipotential bonding (LPZ 1 to 2) and device protection in main and subdistributors.



## Surge arrester for AC energy technology

Type	Highest continuous voltage V	Version	Pack. pcs	Weight kg/100 pcs.	Item No.
<b>V20-C 1+NPE-280</b>	280	1+NPE	1	22,300	<b>5094 65 0</b>
<b>V20-C 3+NPE-280</b>	280	3 + NPE	1	41,700	<b>5094 65 6</b>

/pc.

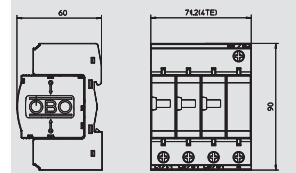

## Surge arrester for AC energy technology with FS

Type	Highest continuous voltage V	Version	Pack. pcs	Weight kg/100 pcs.	Item No.
<b>V20-C 1+NPE+FS</b>	280	1+NPE	1	22,500	<b>5094 76 0</b>
<b>V20-C 3+NPE+FS</b>	280	3 + NPE	1	43,300	<b>5094 76 5</b>

/pc.

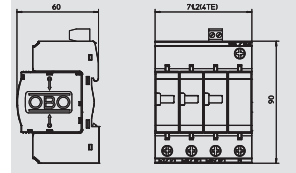

V20-C 1+NPE-280

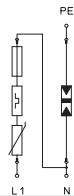

V20-C 3+NPE-280

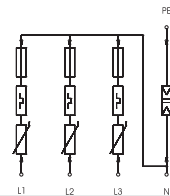

V20-C 1+NPE+FS

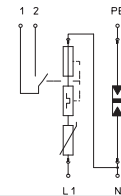

V20-C 3+NPE+FS

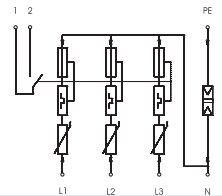

Nominal voltage	V	230 V	230 V	230 V	230 V
SPD to EN 61643-11		Type 2	Type 2	Type 2	Type 2
SPD to IEC 61643-1		class II	class II	class II	class II
LPZ		1→2	1→2	1→2	1→2
Nominal discharge surge current (8/20)	kA	20 kA	20 kA	20 kA	20 kA
Arrester surge current (8/20) [total]	kA	40 kA	120 kA	40 kA	80 kA
Maximum discharge current	kA	40 kA	40 kA	40 kA	40 kA
Voltage protection level	kV	< 1,3 kV	< 1,3 kV	< 1,3 kV	< 1,3 kV
Response time	ns	< 25 ns	< 25 ns	< 25 ns	< 25 ns
Maximum back-up fuse	A	125 A	125 A	125 A	125 A
Temperature range	θ °C	-40 - +80 °C	-40 - +80 °C	-40 - +80 °C	-40 - +80 °C
Division unit TE (17.5 mm)		2	4	2	4
Protection rating		IP20	IP20	IP20	IP20
Connection cross-section, rigid	mm <sup>2</sup>	2,5 - 35 mm <sup>2</sup>	2,5 - 35 mm <sup>2</sup>	2,5 - 35 mm <sup>2</sup>	2,5 - 35 mm <sup>2</sup>
Connection cross-section, multi-wire	mm <sup>2</sup>	2,5 - 35 mm <sup>2</sup>	2,5 - 35 mm <sup>2</sup>	2,5 - 35 mm <sup>2</sup>	2,5 - 35 mm <sup>2</sup>
Connection cross-section, flexible	mm <sup>2</sup>	2,5 - 25 mm <sup>2</sup>	2,5 - 25 mm <sup>2</sup>	2,5 - 25 mm <sup>2</sup>	2,5 - 25 mm <sup>2</sup>
<b>Item No.</b>		<b>5094 65 0</b>	<b>5094 65 6</b>	<b>5094 76 0</b>	<b>5094 76 5</b>

# Surge arrester for data technology

Data cable protection devices for network technology up to 10 GBit/s

- Different connection systems available
- Low protection level at high current load
- Support for Power over Ethernet (POE)
- Tested transmission quality in networks up to 10 GBit (Class EA)
- Quick installation through connectable



Application: 10 GBit Ethernet, 10/100 MBit Ethernet, PoE applications

### Surge arrester for data technology – PoE

Type	Version	Connection system	Pack. pcs	Weight kg/100 pcs.	Item No.
<b>ND-CAT6A/EA</b>	8-pole	RJ45	1	16,600	<b>5081 80 0</b>

/pc.

### Surge arrester for telecommunications technology

Type	Version	Connection system	Pack. pcs	Weight kg/100 pcs.	Item No.
<b>SC-TELE 4-C-G</b>	Combi protection	Terminal	1	30,000	<b>5081 68 8</b>

/pc.

### Surge arrester for HF applications

Type	Pack. pcs	Weight kg/100 pcs.	Item No.
<b>FRD 24 HF</b>	1	4,400	<b>5098 57 5</b>

/pc.

### Surge arrester for MCR circuits

Type	Nominal voltage V	Maximum continuous voltage Vc/AC V	Maximum continuous voltage Vc/DC V	Pack. pcs	Weight kg/100 pcs.	Item No.
<b>MDP-4 D-24-T</b>	24	20	28	1	5,800	<b>5098 43 1</b>

/pc.

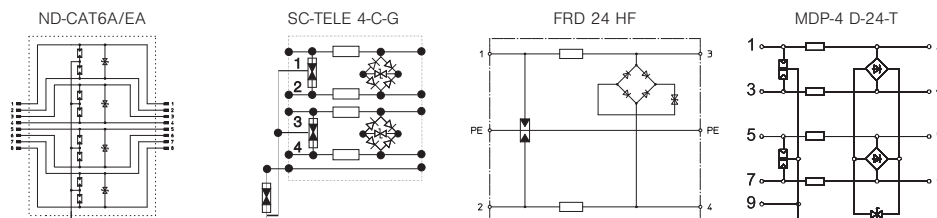

U max AC	V	41 V	122 V		
U max DC	V	58 V	170 V		
LPZ		1→3	0→3		
Lightning impulse current (10/350)	kA	- kA	5 kA		
Rated arresting surge current In to C2 (total)	kA	7 kA	60 kA		
Rated arresting surge current In to C2 (wire-wire)	kA	0,15 kA	15 kA		
Protection level wire/earth	V	<700 V	<500 V	0→3	1→3
Series resistance	R ohm	- ohm	3,3 ohm	< 650 V	< 800 V
Nominal load current	A	1 A	0,75 A	0,45 A	0,58 A
Protection rating		IP 10	IP 54		
Connection system		RJ45	Terminal	Terminal	Terminal
<b>Item No.</b>		<b>5081 80 0</b>	<b>5081 68 8</b>	<b>5098 57 5</b>	<b>5098 43 1</b>



# Lightning current and surge arrester, Type 1+2, photovoltaic systems 600 V DC



Combination arrester, type 2, for photovoltaic systems

- Error-resistant Y circuit for use according to VDE 0100-712 (IEC 60364-7-712)
- For surge voltage protection equipotential bonding to VDE 0100-443 (IEC 60364-4-44)
- Arresting capacity to 40 kA (8/20) per pin
- Low DC protection level: < 2.6 kV (Voc max = 600 V DC)
- Arrester, connectable with thermodynamic cut-off unit and function display
- Encapsulated, non-blow out zinc oxide varistor arrester for use in distributor housings

Application: PV systems with separated insulated lightning protection system



## Complete photovoltaic block V50, 600 V DC

Type	U <sub>max</sub> DC V	Version	Pack. pcs	Weight kg/100 pcs.	Item No.
<b>V50-B+C 3-PH600</b>	600	3-pole for PV systems	1	41,000	<b>5093 62 3</b>

/pc.

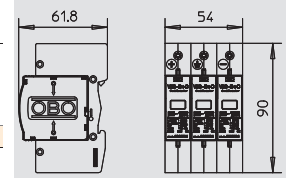

## Complete photovoltaic block V50, 600 V DC with FS

Type	U <sub>max</sub> DC V	Version	Pack. pcs	Weight kg/100 pcs.	Item No.
<b>V50-B+C 3PHFS600</b>	600	3-pole for PV systems with FS	1	49,600	<b>5093 62 5</b>

/pc.

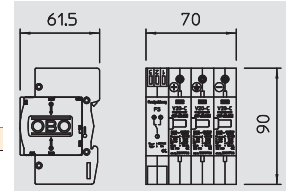

## Complete photovoltaic block V50, 600 V DC

Type	U <sub>max</sub> DC V	Version	Pack. pcs	Weight kg/100 pcs.	Item No.
<b>V50-B+C 2-PH600</b>	600	2-pole for earthed PV systems	1	30,000	<b>5093 62 8</b>

/pc.

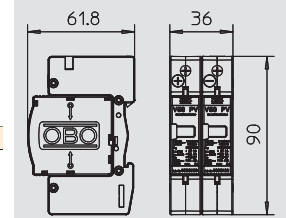

## Complete photovoltaic block V50, 600 V DC with FS

Type	U <sub>max</sub> DC V	Version	Pack. pcs	Weight kg/100 pcs.	Item No.
<b>V50-B+C 2PHFS600</b>	600	2-pole for earthed PV systems with FS	1	24,400	<b>5093 62 9</b>

/pc.

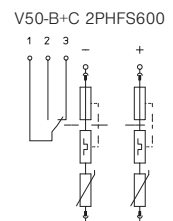
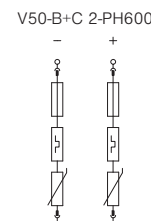
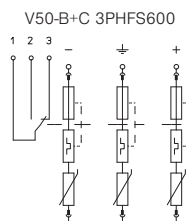
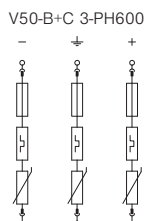
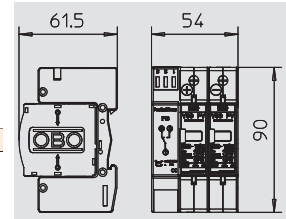

U <sub>max</sub> DC	V	600 V	600 V	600 V	600 V
SPD to EN 61643-11		Type 1+2	Type 1+2	Type 1+2	Type 1+2
LPZ		0→2	0→2	0→2	0→2
Lightning impulse current (10/350)	kA	12,5 kA	12,5 kA	12,5 kA	12,5 kA
Nominal discharge surge current (8/20)	kA	30 kA	30 kA	30 kA	30 kA
Maximum discharge current	kA	50 kA	50 kA	50 kA	50 kA
Voltage protection level	kV	< 2,6 kV	< 2,6 kV	< 2,6 kV	< 2,6 kV
Response time	ns	< 25 ns	< 25 ns	< 25 ns	< 25 ns
Temperature range	θ °C	-40 - +80 °C	-40 - +80 °C	-40 - +80 °C	-40 - +80 °C
Protection rating		IP 20	IP 20	IP 20	IP 20
Division unit TE (17.5 mm)		3	4	2	3
Connection cross-section, rigid	mm <sup>2</sup>	2,5 - 35 mm <sup>2</sup>	2,5 - 35 mm <sup>2</sup>	2,5 - 35 mm <sup>2</sup>	2,5 - 35 mm <sup>2</sup>
Connection cross-section, multi-wire	mm <sup>2</sup>	2,5 - 35 mm <sup>2</sup>	2,5 - 35 mm <sup>2</sup>	2,5 - 35 mm <sup>2</sup>	2,5 - 35 mm <sup>2</sup>
Connection cross-section, flexible	mm <sup>2</sup>	2,5 - 25 mm <sup>2</sup>	2,5 - 25 mm <sup>2</sup>	2,5 - 25 mm <sup>2</sup>	2,5 - 25 mm <sup>2</sup>
<b>Item No.</b>		<b>5093 62 3</b>	<b>5093 62 5</b>	<b>5093 62 8</b>	<b>5093 62 9</b>

# Lightning current and surge arrester, Type 1+2, photovoltaic systems 900 V DC

Combination arrester, type 2, for photovoltaic systems



- Error-resistant Y circuit for use according to VDE 0100-712 (IEC 60364-7-712)
- For surge voltage protection equipotential bonding to VDE 0100-443 (IEC 60364-4-44)
- Arresting capacity to 7 kA (10/350) and 50 kA (8/20) per pin
- Low DC protection level: < 3.0 kV (Voc max = 900 V DC)
- Arrester, connectable with thermodynamic cut-off unit and function display
- Encapsulated, non-extinguishing zinc oxide varistor arrester for use in distributor housings

Application: PV systems with separated insulated lightning protection system

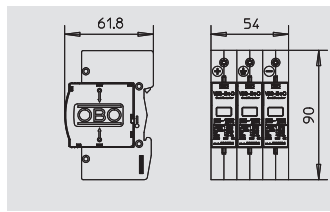

## Complete photovoltaic block V25, 900 V DC

Type	U <sub>max</sub> DC V	Version	Pack. pcs	Weight kg/100 pcs.	Item No.
V25-B+C 3-PH900	900	3-pole for PV systems	1	42,200	5097 44 7



/pc.

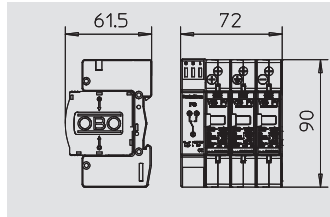

## Complete photovoltaic block V25, 900 V DC with FS

Type	U <sub>max</sub> DC V	Version	Pack. pcs	Weight kg/100 pcs.	Item No.
V25-B+C 3PHFS900	900	3-pole for PV systems with FS	1	53,500	5097 44 8



/pc.

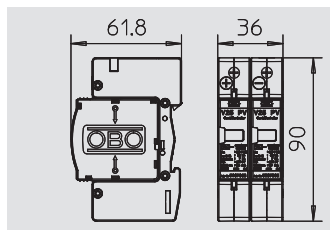

## Complete photovoltaic block V25, 900 V DC

Type	U <sub>max</sub> DC V	Version	Pack. pcs	Weight kg/100 pcs.	Item No.
V25-B+C 2-PH900	900	2-pole for earthed PV systems	1	30,800	5097 45 7



/pc.

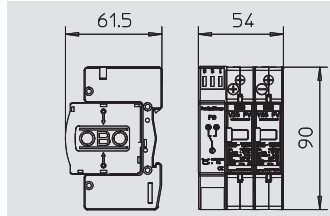

## Complete photovoltaic block V25, 900 V DC with FS

Type	U <sub>max</sub> DC V	Version	Pack. pcs	Weight kg/100 pcs.	Item No.
V25-B+C 2PHFS900	900	2-pole for earthed PV systems with FS	1	37,000	5097 45 8



/pc.

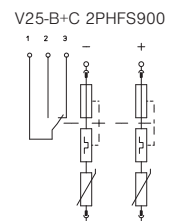
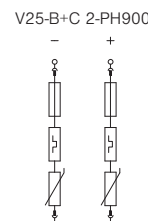
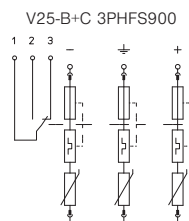
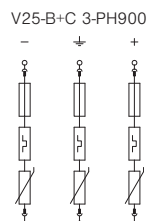

U <sub>max</sub> DC	V	900 V	900 V	900 V	900 V
SPD to EN 61643-11		Type 1+2	Type 1+2	Type 1+2	Type 1+2
LPZ		0-2	0-2	0-2	0-2
Lightning impulse current (10/350)	kA	7 kA	7 kA	7 kA	7 kA
Nominal discharge surge current (8/20)	kA	30 kA	30 kA	30 kA	30 kA
Maximum discharge current	kA	50 kA	50 kA	50 kA	50 kA
Voltage protection level	kV	< 3,0 kV	< 3,0 kV	< 3,0 kV	< 3,0 kV
Response time	ns	< 25 ns	< 25 ns	< 25 ns	< 25 ns
Temperature range	θ °C	-40 - +80 °C	-40 - +80 °C	-40 - +80 °C	-40 - +80 °C
Protection rating		IP 20	IP 20	IP 20	IP 20
Division unit TE (17,5 mm)		3	4	2	3
Connection cross-section, rigid	mm <sup>2</sup>	2,5 - 35 mm <sup>2</sup>	2,5 - 35 mm <sup>2</sup>	2,5 - 35 mm <sup>2</sup>	2,5 - 35 mm <sup>2</sup>
Connection cross-section, multi-wire	mm <sup>2</sup>	2,5 - 35 mm <sup>2</sup>	2,5 - 35 mm <sup>2</sup>	2,5 - 35 mm <sup>2</sup>	2,5 - 35 mm <sup>2</sup>
Connection cross-section, flexible	mm <sup>2</sup>	2,5 - 25 mm <sup>2</sup>	2,5 - 25 mm <sup>2</sup>	2,5 - 25 mm <sup>2</sup>	2,5 - 25 mm <sup>2</sup>
<b>Item No.</b>		<b>5097 44 7</b>	<b>5097 44 8</b>	<b>5097 45 7</b>	<b>5097 45 8</b>

12 LPA Lösungskatalog Photovoltaik\_2011\_Neu / en / 25/08/2011 (LLExpport\_01327)

# Surge arrester, Type 2, photovoltaics 600 V DC



Surge arrester, Type 2, for photovoltaic systems

- Error-resistant Y circuit for use according to VDE 0100-712 (IEC 60364-7-712)
- For surge voltage protection equipotential bonding to VDE 0100-443 (IEC 60364-4-44)
- Arresting capacity to 40 kA (8/20) per pin
- Low DC protection level: < 2.6 kV (Voc max = 600 V DC)
- Arrester, connectable with thermodynamic cut-off unit and function display
- Encapsulated, non-extinguishing zinc oxide varistor arrester for use in distributor housings

Application: PV systems with or without separated insulated lightning protection system



## Complete photovoltaic block V20, 600 V DC

Type	U <sub>max</sub> DC V	Version	Pack. pcs	Weight kg/100 pcs.	Item No.
<b>V20-C 3PH-600</b>	600	3-pole for PV systems	1	33,500	<b>5094 60 5</b>

/pc.

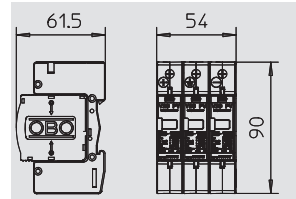

## Complete photovoltaic block V20, 600 V DC with FS

Type	U <sub>max</sub> DC V	Version	Pack. pcs	Weight kg/100 pcs.	Item No.
<b>V20-C 3PHFS-600</b>	600	3-pole for PV systems with FS	1	41,500	<b>5094 57 6</b>

/pc.

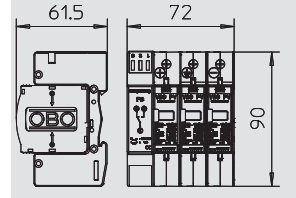

## Complete photovoltaic block V20, 600 V DC

Type	U <sub>max</sub> DC V	Version	Pack. pcs	Weight kg/100 pcs.	Item No.
<b>V20-C 2PH-600</b>	600	2-pole for earthed PV systems	1	25,000	<b>5094 61 3</b>

/pc.

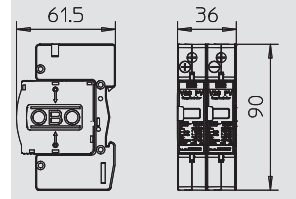

## Complete photovoltaic block V20, 600 V DC with FS

Type	U <sub>max</sub> DC V	Version	Pack. pcs	Weight kg/100 pcs.	Item No.
<b>V20-C 2PHFS-600</b>	600	2-pole for earthed PV systems with FS	1	29,000	<b>5094 57 2</b>

/pc.

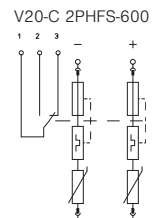
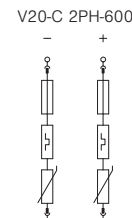
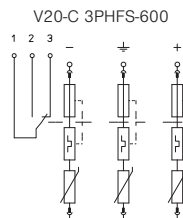
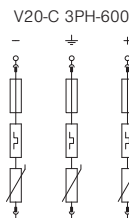
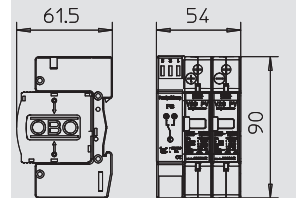

U <sub>max</sub> DC	V	600 V	600 V	600 V	600 V
SPD to EN 61643-11		Type 2	Type 2	Type 2	Type 2
LPZ		1-2	1-2	1-2	1-2
Nominal discharge surge current (8/20)	kA	20 kA	20 kA	20 kA	20 kA
Maximum discharge current	kA	40 kA	40 kA	40 kA	40 kA
Voltage protection level	kV	< 2,6 kV	< 2,6 kV	< 2,6 kV	< 2,6 kV
Response time	ns	< 25 ns	< 25 ns	< 25 ns	< 25 ns
Temperature range	θ °C	-40 - +80 °C	-40 - +80 °C	-40 - +80 °C	-40 - +80 °C
Protection rating		IP 20	IP 20	IP 20	IP 20
Division unit TE (17.5 mm)		3	4	2	3
Connection cross-section, rigid	mm <sup>2</sup>	2,5 - 35 mm <sup>2</sup>	2,5 - 35 mm <sup>2</sup>	2,5 - 35 mm <sup>2</sup>	2,5 - 35 mm <sup>2</sup>
Connection cross-section, multi-wire	mm <sup>2</sup>	2,5 - 35 mm <sup>2</sup>	2,5 - 35 mm <sup>2</sup>	2,5 - 35 mm <sup>2</sup>	2,5 - 35 mm <sup>2</sup>
Connection cross-section, flexible	mm <sup>2</sup>	2,5 - 25 mm <sup>2</sup>	2,5 - 25 mm <sup>2</sup>	2,5 - 25 mm <sup>2</sup>	2,5 - 25 mm <sup>2</sup>
<b>Item No.</b>		<b>5094 60 5</b>	<b>5094 57 6</b>	<b>5094 61 3</b>	<b>5094 57 2</b>



# Surge arrester, Type 2, photovoltaics 1,000 V DC

Surge arrester, Type 2, for photovoltaic systems



- Error-resistant Y circuit for use according to VDE 0100-712 (IEC 60364-7-712)
- For surge voltage protection equipotential bonding to VDE 0100-443 (IEC 60364-4-44)
- Arresting capacity to 40 kA (8/20) per pin
- Low DC protection level: < 4.0 kV (Voc max = 1,000 V DC)
- Arrester, connectable with thermodynamic cut-off unit and function display
- Encapsulated, non-extinguishing zinc oxide varistor arrester for use in distributor housings

Application: PV systems with or without separated insulated lightning protection system

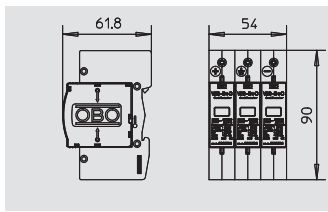

## Complete photovoltaic block V20, 1,000 V DC

Type	U <sub>max</sub> DC V	Version	Pack. pcs	Weight kg/100 pcs.	Item No.
V20-C 3-PH-1000	1000	3-pole for PV systems	1	36,500	5094 60 8



/pc.

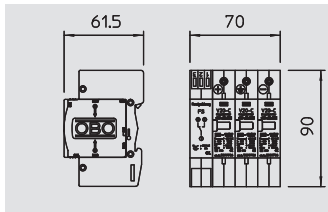

## Complete photovoltaic block V20, 1,000 V DC with FS

Type	U <sub>max</sub> DC V	Version	Pack. pcs	Weight kg/100 pcs.	Item No.
V20-C 3PHFS-1000	1000	3-pole for PV systems with FS	1	44,500	5094 57 4



/pc.

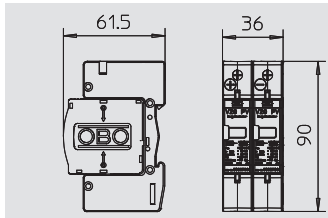

## Complete photovoltaic block V20, 1,000 V DC

Type	U <sub>max</sub> DC V	Version	Pack. pcs	Weight kg/100 pcs.	Item No.
V20-C 2-PH-1000	1000	2-pole for earthed PV systems	1	27,000	5094 61 7



/pc.

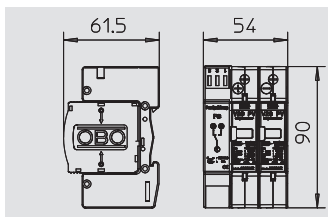

## Complete photovoltaic block V20, 1,000 V DC with FS

Type	U <sub>max</sub> DC V	Version	Pack. pcs	Weight kg/100 pcs.	Item No.
V20-C 2PHFS-1000	1000	2-pole for earthed PV systems with FS	1	31,000	5094 61 5



/pc.

V20-C 3-PH-1000

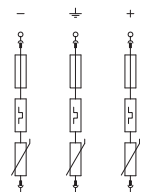

V20-C 3PHFS-1000

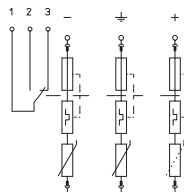

V20-C 2-PH-1000

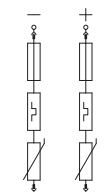

V20-C 2PHFS-1000

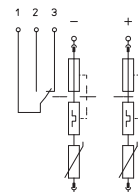

U <sub>max</sub> DC	V	1000 V	1000 V	1000 V	1000 V
SPD to EN 61643-11		Type 2	Type 2	Type 2	Type 2
LPZ		1→2	1→2	1→2	1→2
Nominal discharge surge current (8/20)	kA	20 kA	20 kA	20 kA	20 kA
Maximum discharge current	kA	40 kA	40 kA	40 kA	40 kA
Voltage protection level	kV	< 4,0 kV	< 4,0 kV	< 4,0 kV	< 4,0 kV
Response time	ns	< 25 ns	< 25 ns	< 25 ns	< 25 ns
Temperature range	θ °C	-40 - +80 °C	-40 - +80 °C	-40 - +80 °C	-40 - +80 °C
Protection rating		IP 20	IP 20	IP 20	IP 20
Division unit TE (17,5 mm)		3	4	2	3
Connection cross-section, rigid	mm <sup>2</sup>	2,5 - 35 mm <sup>2</sup>	2,5 - 35 mm <sup>2</sup>	2,5 - 35 mm <sup>2</sup>	2,5 - 35 mm <sup>2</sup>
Connection cross-section, multi-wire	mm <sup>2</sup>	2,5 - 35 mm <sup>2</sup>	2,5 - 35 mm <sup>2</sup>	2,5 - 35 mm <sup>2</sup>	2,5 - 35 mm <sup>2</sup>
Connection cross-section, flexible	mm <sup>2</sup>	2,5 - 25 mm <sup>2</sup>	2,5 - 25 mm <sup>2</sup>	2,5 - 25 mm <sup>2</sup>	2,5 - 25 mm <sup>2</sup>
<b>Item No.</b>		<b>5094 60 8</b>	<b>5094 57 4</b>	<b>5094 61 7</b>	<b>5094 61 5</b>

12 LPA Lösungskatalog Photovoltaik\_2011\_Neu / en / 25/08/2011 (LLEExport\_01327)

# Photovoltaic housing with V-Tec entry set



System solution for photovoltaic systems with connection terminals and entry set

- Error-resistant Y circuit with 3 varistors for use according to VDE 0100-712
- Low DC protection level: < 4.0 kV (Voc max = 1,000 V DC with V20-C/0-500PV)
- 5 parallel connection terminals to 6 mm<sup>2</sup> per polarity (+ and -)
- V-Tec entries set included
- Arrester, connectable with thermodynamic cut-off unit and visual function display
- Encapsulated, non-extinguishing zinc oxide varistor arrester for use in distributor housings
- Polycarbonate housing, weatherproof for outdoor use.

Note: 5 PV strings can be switched in parallel on the terminals. The technical data (string voltage, etc.) and the conditions of the converter (number of MPP trackers) must be taken into account. Additional measures may be necessary if there is the risk of condensation formation.

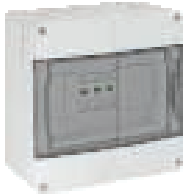

## Photovoltaic housing with 4 terminals

Type	U <sub>max</sub> DC V	Version	Pack. pcs	Weight kg/100 pcs.	Item No.
<b>VG-C DCPH1000-4K</b>	1000	Type 2 in housing with V-Tec insertion	1	162,000	<b>5088 65 0</b>

/pc.

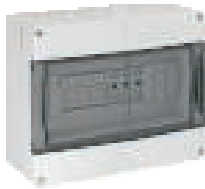
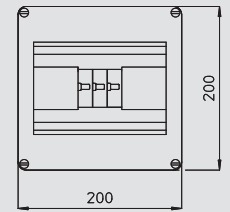

## Photovoltaic housing with 4 fuses

Type	U <sub>max</sub> DC V	Version	Pack. pcs	Weight kg/100 pcs.	Item No.
<b>VG-C DCPH1000-4S</b>	1000	Type 2 in housing with 4 PV fuses	1	200,000	<b>5088 65 1</b>

/pc.

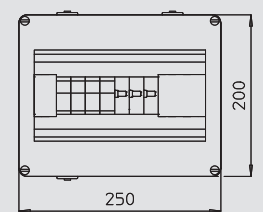

## Photovoltaic housing with 6 fuses

Type	U <sub>max</sub> DC V	Version	Pack. pcs	Weight kg/100 pcs.	Item No.
<b>VG-C DCPH1000-6S</b>	1000	Type 2 in housing with 6 PV fuses	1	370,000	<b>5088 65 2</b>

/pc.

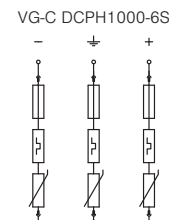
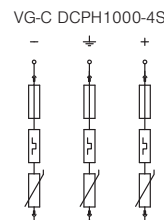
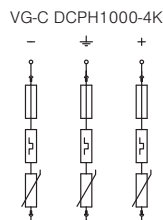
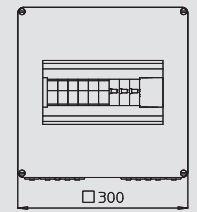

U <sub>max</sub> DC	V	1000 V	1000 V	1000 V
SPD to EN 61643-11		Type 2	Type 2	Type 2
LPZ		1→2	1→2	1→2
Nominal discharge surge current (8/20)	kA	20 kA	20 kA	20 kA
Maximum discharge current	kA	40 kA	40 kA	40 kA
Voltage protection level	kV	< 4,0 kV	< 4,0 kV	< 4,0 kV
Response time	ns	< 25 ns	< 25 ns	< 25 ns
Connection cross-section, rigid	mm <sup>2</sup>	0,5 - 6 mm <sup>2</sup>	0,5 - 6 mm <sup>2</sup>	0,5 - 10 mm <sup>2</sup>
Connection cross-section, flexible	mm <sup>2</sup>	0,5 - 6 mm <sup>2</sup>	0,5 - 6 mm <sup>2</sup>	0,5 - 10 mm <sup>2</sup>
Temperature range	∅ °C	-40 - +80 °C	-40 - +80 °C	-40 - +80 °C
Protection rating		IP 65	IP 65	IP 65
<b>Item No.</b>		<b>5088 65 0</b>	<b>5088 65 1</b>	<b>5088 65 2</b>

# Photovoltaic housing for WR with multiple MPP trackers

System solution for PV converters with 2 / 3 separate MPP trackers



- Error-resistant Y circuit with 3 varistors for use according to VDE 0100-712
- Low DC protection level: < 4.0 kV (Voc max = 1,000 V DC with V20-C/0-500PV)
- Two PV string inputs on each MPP-WR input, I<sub>max</sub> = 15 A DC per PV string
- DC connection compatible with MC4 plug connector (Series: PV-AD...P 4/6)
- Arrester, connectable with dynamic cut-off unit and visual function display
- Encapsulated, non-extinguishing zinc oxide varistor arrester for use in distributor housings
- Polycarbonate housing, weatherproof for outdoor use.

Application: PV system for DC protection of the inverter

Additional measures may be necessary if there is the risk of condensation formation.

## Photovoltaic housing for WR with 2 MPP trackers

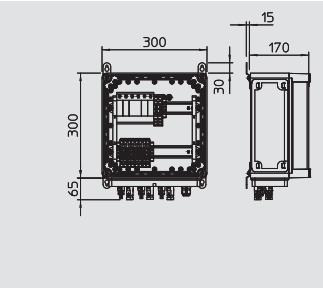

Type	U <sub>max</sub> DC V	Version	Pack. pcs	Weight kg/100 pcs.	Item No.
<b>VG-C DCPH1000-21</b>	1000	Protection for two separate MPP trackers	1	419,800	<b>5088 64 6</b>



/pc.

## Photovoltaic housing for WR with 3 MPP trackers

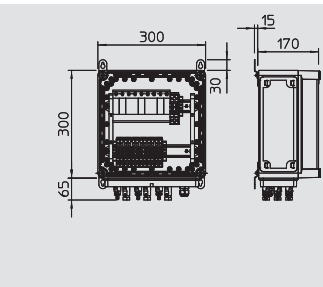

Type	U <sub>max</sub> DC V	Version	Pack. pcs	Weight kg/100 pcs.	Item No.
<b>VG-C DCPH1000-31</b>	1000	Protection for three separate MPP trackers	1	524,500	<b>5088 64 8</b>



/pc.

VG-C DCPH1000-21

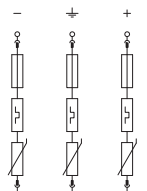

VG-C DCPH1000-31

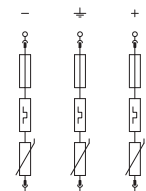

U <sub>max</sub> DC	V	1000 V	1000 V
SPD to EN 61643-11		Type 2	Type 2
LPZ		1→2	1→2
Nominal discharge surge current (8/20)	kA	20 kA	20 kA
Maximum discharge current	kA	40 kA	40 kA
Voltage protection level	kV	< 4,0 kV	< 4,0 kV
Response time	ns	< 25 ns	< 25 ns
Temperature range	θ °C	-40 - +80 °C	-40 - +80 °C
Protection rating		IP65	IP65
<b>Item No.</b>		<b>5088 64 6</b>	<b>5088 64 8</b>



# Photovoltaic housing with connection terminals

Type 1+2	Type 2	LPZ 0→1	LPZ 1→2
----------	--------	---------	---------



System solution for photovoltaic systems with connection terminals

- Error-resistant Y circuit with 3 varistors for use according to VDE 0100-712 (IEC 60364-7-712)
- Low DC protection level: < 4.0 kV (Voc max = 1,000 V DC with V20-C/0-500PV)
- Low DC protection level: < 3.0 kV (Voc max = 900 V DC with V25-B+C/0-450PV)
- Low DC protection level: < 2.6 kV (Voc max = 600 V DC with V50-B+C/0-300PV)
- 6 parallel connection terminals up to 6 mm<sup>2</sup> for each polarity (+ and -)
- Pre-mounted in IP65 housing

Note: 5 PV strings can be switched in parallel on the terminals. The technical data (string voltage, etc.) and the conditions of the inverter (number of MPP trackers) must be taken into account.

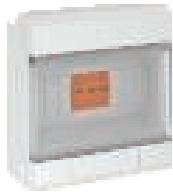

## Photovoltaic housing with connection terminals, Type 1+2, 600 V DC

Type	U <sub>max</sub> DC V	Version	Pack. pcs	Weight kg/100 pcs.	Item No.
<b>VG-BC DCPH-MS600</b>	600	Type 1+2 in housing with terminals	1	159,000	<b>5088 69 3</b>

/pc.

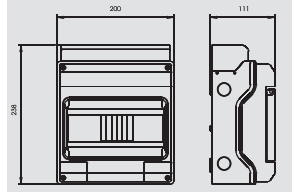

## Photovoltaic housing with connection terminals, Type 1+2, 900 V DC

Type	U <sub>max</sub> DC V	Version	Pack. pcs	Weight kg/100 pcs.	Item No.
<b>VG-BC DCPH-MS900</b>	900	Type 1+2 in housing with terminals	1	160,000	<b>5088 69 2</b>

/pc.

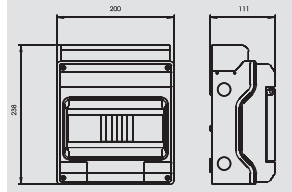

## Photovoltaic housing with connection terminals, Type 2, 1,000 V DC

Type	U <sub>max</sub> DC V	Version	Pack. pcs	Weight kg/100 pcs.	Item No.
<b>VG-C DCPH-MS1000</b>	1000	Type 2 in housing with terminals	1	154,000	<b>5088 69 1</b>

/pc.

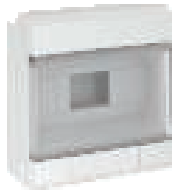
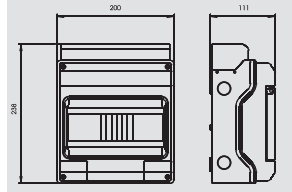

## Photovoltaic housing with connection terminals

Type	U <sub>max</sub> DC V	Version	Pack. pcs	Weight kg/100 pcs.	Item No.
<b>VG-C DC-PH-MS</b>	—	Pre-mounted without arrester covers in housing with terminals	1	135,000	<b>5088 69 4</b>

/pc.

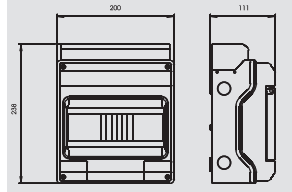

VG-BC DCPH-MS600

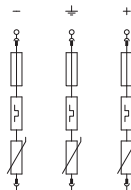

VG-BC DCPH-MS900

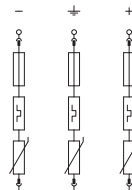

VG-C DCPH-MS1000

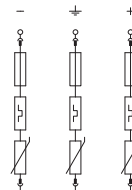

VG-C DC-PH-MS

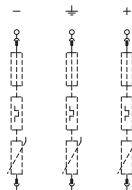

U <sub>max</sub> DC	V	600 V	900 V	1000 V	
SPD to EN 61643-11		Type 1+2	Type 1+2	Type 2	
LPZ		0→2	0→2	1→2	
Lightning impulse current (10/350)	kA	12,5 kA	7 kA		
Nominal discharge surge current (8/20)	kA	30 kA	30 kA	20 kA	
Maximum discharge current	kA	50 kA	50 kA	40 kA	
Voltage protection level	kV	< 2,6 kV	< 3,0 kV	< 4,0 kV	
Response time	ns	< 25 ns	< 25 ns	< 25 ns	
Connection cross-section, rigid	mm <sup>2</sup>	0,5 - 6 mm <sup>2</sup>	0,5 - 6 mm <sup>2</sup>	0,5 - 6 mm <sup>2</sup>	0,5 - 6 mm <sup>2</sup>
Connection cross-section, flexible	mm <sup>2</sup>	0,5 - 6 mm <sup>2</sup>	0,5 - 6 mm <sup>2</sup>	0,5 - 6 mm <sup>2</sup>	0,5 - 6 mm <sup>2</sup>
Temperature range	∅ °C	-40 - +80 °C	-40 - +80 °C	-40 - +80 °C	-40 - +80 °C
Protection rating		IP 65	IP 65	IP 65	IP 65
<b>Item No.</b>		<b>5088 69 3</b>	<b>5088 69 2</b>	<b>5088 69 1</b>	<b>5088 69 4</b>

# Photovoltaic housing with connection terminals with FS

System solution for photovoltaic systems with connection terminals and remote signalling



- Error-resistant Y circuit for use according to VDE 0100-712 (IEC 60364-7-712)
- Low DC protection level: < 3.0 kV (Voc max = 900 V DC with V25-B+C/0-450PV)
- Low DC protection level: < 2.6 kV (Voc max = 600 V DC with V50-B+C/0-300PV)
- 5 parallel connection terminals up to 6 mm<sup>2</sup> for each polarity (+ and -)
- Pre-mounted in IP65 housing

Note: 5 PV strings can be switched in parallel on the terminals. The technical data (string voltage, etc.) and the conditions of the converter (number of MPP trackers) must be taken into account.

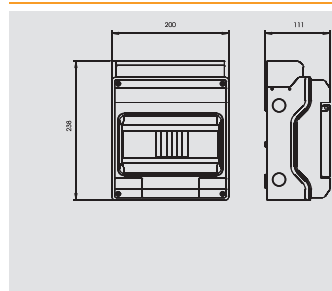

## Photovoltaic housing with 600 V DC connection terminals with FS

Type	U max DC V	Version	Pack. pcs	Weight kg/100 pcs.	Item No.
<b>VG-BC DC-MSFS600</b>	600	Type 1+2 with FS in housing with terminals	1	167,000	<b>5088 69 5</b>



/pc.

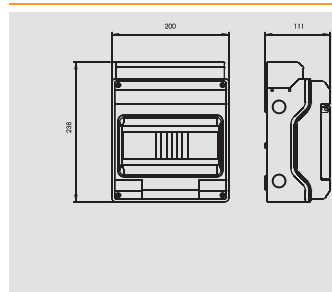

## Photovoltaic housing 900 V DC with connection terminals with FS

Type	U max DC V	Version	Pack. pcs	Weight kg/100 pcs.	Item No.
<b>VG-BC DC-MSFS900</b>	900	Type 1+2 with FS in housing with terminals	1	168,000	<b>5088 69 6</b>



/pc.

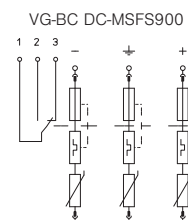
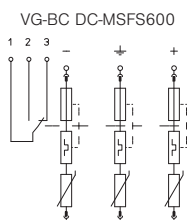

U max DC	V	600 V	900 V
SPD to EN 61643-11		Type 1+2	Type 1+2
LPZ		0→2	0→2
Lightning impulse current (10/350)	kA	12,5 kA	7 kA
Nominal discharge surge current (8/20)	kA	30 kA	30 kA
Maximum discharge current	kA	50 kA	60 kA
Voltage protection level	kV	< 2,6 kV	< 3,0 kV
Response time	ns	< 25 ns	< 25 ns
Connection cross-section, rigid	mm <sup>2</sup>	0,5 - 6 mm <sup>2</sup>	0,5 - 6 mm <sup>2</sup>
Connection cross-section, flexible	mm <sup>2</sup>	0,5 - 6 mm <sup>2</sup>	0,5 - 6 mm <sup>2</sup>
Temperature range	θ °C	-40 - +80 °C	-40 - +80 °C
Protection rating		IP 65	IP 65
<b>Item No.</b>		<b>5088 69 5</b>	<b>5088 69 6</b>

# Photovoltaic system solution with MC 4 connector

Type	LPZ	Type	LPZ
2	1→2	1+2	0→2



System solution for photovoltaic systems with MC4 connector

- Error-resistant Y circuit for use according to VDE 0100-712 (IEC 60364-7-712)
- Low DC protection level: < 4.0 kV (Voc max = 1,000 V DC with V20-C/0-500PV)
- Low DC protection level: < 3.0 kV (Voc max = 900 V DC with V25-B+C/0-450PV)
- Low DC protection level: < 2.6 kV (Voc max = 600 V DC with V50-B+C/0-300PV)
- DC connection with MC4 plug connector (Series: PV-AD...P 4/6), pre-mounted in IP65 housing

Application: PV systems to protect the inverter



## Photovoltaic system solution, Type 1+2, with MC connector, 600 V DC

Type	U <sub>max</sub> DC V	Version	Pack. pcs	Weight kg/100 pcs.	Item No.
<b>VG-BC DCPH-Y600</b>	600	Equipped in housing with MC4 connector	1	174,600	<b>5088 67 6</b>

/pc.

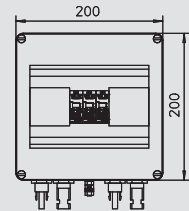

## Photovoltaic system solution, Type 1+2, with MC connector, 900 V DC

Type	U <sub>max</sub> DC V	Version	Pack. pcs	Weight kg/100 pcs.	Item No.
<b>VG-BC DCPH-Y900</b>	900	Equipped in housing with MC4 connector	1	178,500	<b>5088 67 8</b>

/pc.

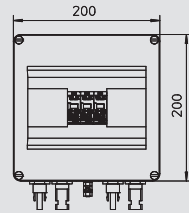

## Photovoltaic system solution, Type 2, with MC connector, 600 V DC

Type	U <sub>max</sub> DC V	Version	Pack. pcs	Weight kg/100 pcs.	Item No.
<b>VG-C DCPH-Y600</b>	600	Equipped in housing with MC4 connector	1	166,500	<b>5088 67 0</b>

/pc.

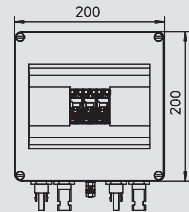

## Photovoltaic system solution, Type 2, with MC connector, 1,000 V DC

Type	U <sub>max</sub> DC V	Version	Pack. pcs	Weight kg/100 pcs.	Item No.
<b>VG-C DCPH-Y1000</b>	1000	Equipped in housing with MC4 connector	1	169,500	<b>5088 67 2</b>

/pc.

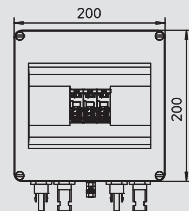

VG-BC DCPH-Y600

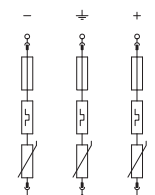

VG-BC DCPH-Y900

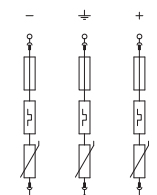

VG-C DCPH-Y600

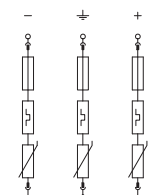

VG-C DCPH-Y1000

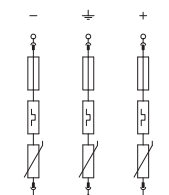

U <sub>max</sub> DC	V	600 V	900 V	600 V	1000 V
SPD to EN 61643-11		Type 1+2	Type 1+2	Type 2	Type 2
LPZ		0→2	0→2	1→2	1→2
Lightning impulse current (10/350)	kA	12,5 kA	7 kA		
Nominal discharge surge current (8/20)	kA	30 kA	30 kA	20 kA	20 kA
Maximum discharge current	kA	50 kA	50 kA	40 kA	40 kA
Voltage protection level	kV	< 2,6 kV	< 3,0 kV	< 2,6 kV	< 4,0 kV
Response time	ns	< 25 ns	< 25 ns	< 25 ns	< 25 ns
Temperature range	∅ °C	-40 - +80 °C	-40 - +80 °C	-40 - +80 °C	-40 - +80 °C
Protection rating		IP65	IP65	IP65	IP65
<b>Item No.</b>		<b>5088 67 6</b>	<b>5088 67 8</b>	<b>5088 67 0</b>	<b>5088 67 2</b>

# Photovoltaic system solutions with MC 4 connector, unequipped

System solution for photovoltaic systems with MC4 connector



- Error-resistant Y circuit for use according to VDE 0100-712 (IEC 60364-7-712)
- Low DC protection level: < 4.0 kV (Voc max = 1,000 V DC with V20-C/0-500PV)
- Low DC protection level: < 3.0 kV (Voc max = 900 V DC with V25-B+C/0-450PV)
- Low DC protection level: < 2.6 kV (Voc max = 600 V DC with V50-B+C/0-300PV)
- DC connection with MC4 plug connector (Series: PV-AD...P 4/6), pre-mounted in IP65 housing

Unequipped, order covers separately.

Application: PV systems to protect the inverter

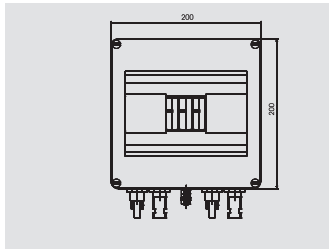

## Surge arrester, photovoltaic system solution

Type	Version	Pack.	Item No.
<b>VG-C DC-PH-Y</b>	Pre-mounted without arrester covers in housing with MC4 connector	1 pcs	<b>5088 69 9</b>



/pc.

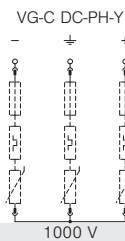

U max DC	V	
SPD to EN 61643-11		
LPZ		
Lightning impulse current (10/350)	kA	
Nominal discharge surge current (8/20)	kA	
Maximum discharge current	kA	
Voltage protection level	kV	
Response time	ns	
Temperature range	θ	-40 - +80 °C
Protection rating		IP 65
<b>Item No.</b>		<b>5088 69 9</b>



# Photovoltaic covers

Type 1+2	Type 2	LPZ 0→1	LPZ 1→2
----------	--------	---------	---------



Cover, combination and surge controller, Type 1+2 and 2 arrestors for photovoltaic systems

- Lightning and surge voltage protection equipotential bonding to VDE 0100-443 (IEC 60364-4-44)
- Arresting capacity to 12.5 kA (10/350) and 50 kA (8/20) per pin
- DC protection level: < 2.0 kV per pole (for Y circuit: 40 kV and Voc to 1000 V DC)
- arrestor, connectable with thermodynamic cut-off unit and function display
- Encapsulated, non-blow out zinc oxide varistor arrestor for use in distributor housings
- High current carrying capacity with long lifespan

Application: Surge and lightning protection for PV systems



## Photovoltaic cover – lightning and surge arresters

Type	U <sub>max</sub> DC V	Version	Pack. pcs	Weight kg/100 pcs.	Item No.
<b>V50-B+C 0-300PV</b>	300	1-pole, PV cover, Type 1+2	1	8,200	<b>5093 72 6</b>

/pc.

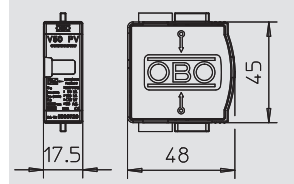

## Photovoltaic cover – lightning and surge arresters

Type	U <sub>max</sub> DC V	Version	Pack. pcs	Weight kg/100 pcs.	Item No.
<b>V25-B+C 0-450PV</b>	450	1-pole, PV cover, Type 1+2	1	9,500	<b>5097 06 5</b>

/pc.

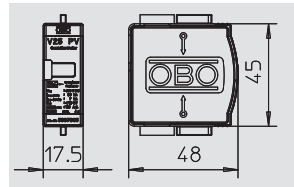

## Photovoltaic cover – surge arresters

Type	U <sub>max</sub> DC V	Version	Pack. pcs	Weight kg/100 pcs.	Item No.
<b>V20-C 0-300PV</b>	300	1-pole, PV cover, type 2	1	5,500	<b>5099 61 1</b>

/pc.

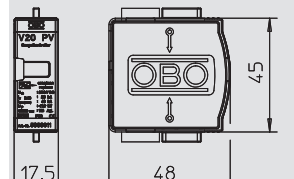

## Photovoltaic cover – surge arresters

Type	U <sub>max</sub> DC V	Version	Pack. pcs	Weight kg/100 pcs.	Item No.
<b>V20-C 0-500PV</b>	500	1-pole, PV cover, type 2	1	6,500	<b>5099 70 8</b>

/pc.

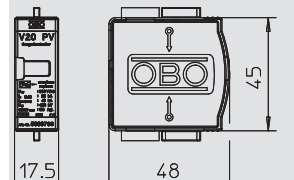

V50-B+C 0-300PV



V25-B+C 0-450PV



V20-C 0-300PV



V20-C 0-500PV



U <sub>max</sub> DC	V	300 V	450 V	300 V	500 V
SPD to EN 61643-11		Type 1+2	Type 1+2	Type 2	Type 2
SPD to IEC 61643-1		class I+II	class I+II	class II	class II
LPZ		0→2	0→2	1→2	1→2
Nominal discharge surge current (8/20)	kA	30 kA	30 kA	20 kA	20 kA
Lightning impulse current (10/350)	kA	12,5 kA	7 kA		
Maximum discharge current	kA	50 kA	50 kA	40 kA	40 kA
Voltage protection level	kV	< 1,3 kV	< 1,5 kV	< 1,3 kV	< 2,0 kV
Response time	ns	<25 ns	< 25 ns	< 25 ns	< 25 ns
Maximum back-up fuse	A	125 A	160 A	125 A	125 A
Temperature range	°C	-40 - +80 °C	-40 - +80 °C	-40 - +80 °C	-40 - +80 °C
Protection rating		IP 20	IP 20	IP 20	IP 20
Division unit TE (17.5 mm)		1	1	1	1
<b>Item No.</b>		<b>5093 72 6</b>	<b>5097 06 5</b>	<b>5099 61 1</b>	<b>5099 70 8</b>

Base for combination and surge controller, Type 1+2 and 2 for photovoltaic systems

Type 1+2	Type 2	LPZ 0→1	LPZ 1→2
FS	5		

- Error resistant Y circuit with 3 varistors (2 for earthed systems)
- Lightning and surge voltage protection equipotential bonding to VDE 0100-443 (IEC 60364-4-44)
- Arresting capacity to 12.5 kA (10/350) and 50 kA (8/20) per pin
- DC protection level: < 2.0 kV per pole (Y circuit: 4.0 kV and max. Voc to 1,000 V DC)
- Encapsulated, non-extinguishing zinc oxide varistor arrester for use in distributor housings
- High current carrying capacity with long lifespan
- Bases unequipped

Application: Surge and lightning protection for PV systems

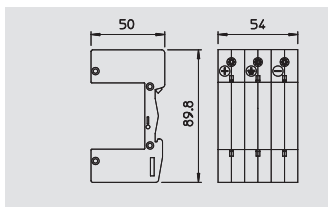

### PV base, 3-pole in Y circuit

Type	Version	Pack.	Weight	Item No.
		pcs	kg/100 pcs.	
<b>V20-C U-3PH-Y</b>	3-pole Y circuit for PV	1	17,000	<b>5096 64 7</b>

/pc.

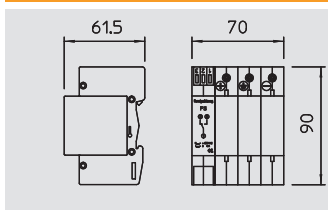

### PV base, 3-pole in Y circuit with remote signalling

Type	Version	Pack.	Weight	Item No.
		pcs	kg/100 pcs.	
<b>V20-C U-3PH-Y-FS</b>	3-pole Y circuit for photovoltaic systems with FS	1	25,000	<b>5096 64 6</b>

/pc.

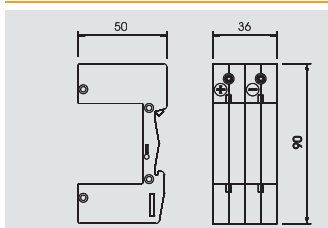

### PV base, 2-pole in Y circuit

Type	Version	Pack.	Weight	Item No.
		pcs	kg/100 pcs.	
<b>V20-C U-2 PH</b>	2-pole for earthed PV systems	1	14,000	<b>5096 63 7</b>

/pc.

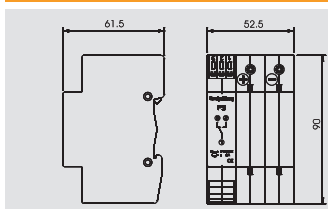

### PV base, 2-pole in Y circuit with remote signalling

Type	Version	Pack.	Weight	Item No.
		pcs	kg/100 pcs.	
<b>V20-C U-2 PH+FS</b>	2-pole for earthed PV systems with FS	1	18,000	<b>5096 63 9</b>

/pc.



12 LPA Lösungskatalog Photovoltaik\_2011\_Neu / en / 25/08/2011 (LLExpport\_01327)

V20-C U-3PH-Y

V20-C U-3PH-Y-FS

V20-C U-2 PH



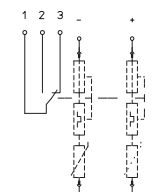
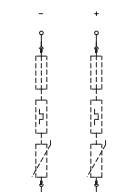
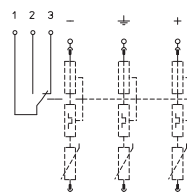

V20-C U-2 PH+FS



Temperature range	θ	°C	-40 - +80 °C	-40 - +80 °C	-40 - +80 °C	-40 - +80 °C
Protection rating			IP 20	IP 20	IP 20	IP 20
Division unit TE (17.5 mm)			3	4	2	3
Connection cross-section, rigid	mm <sup>2</sup>		2,5 - 35 mm <sup>2</sup>	2,5 - 35 mm <sup>2</sup>	2,5 - 35 mm <sup>2</sup>	2,5 - 35 mm <sup>2</sup>
Connection cross-section, multi-wire	mm <sup>2</sup>		2,5 - 35 mm <sup>2</sup>	2,5 - 35 mm <sup>2</sup>	2,5 - 35 mm <sup>2</sup>	2,5 - 35 mm <sup>2</sup>
Connection cross-section, flexible	mm <sup>2</sup>		2,5 - 25 mm <sup>2</sup>	2,5 - 25 mm <sup>2</sup>	2,5 - 25 mm <sup>2</sup>	2,5 - 25 mm <sup>2</sup>
<b>Item No.</b>			<b>5096 64 7</b>	<b>5096 64 6</b>	<b>5096 63 7</b>	<b>5096 63 9</b>

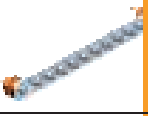

## Equipotential bonding systems

	Equipotential bonding systems, interior areas	66
	Equipotential bonding systems, outdoor areas	66
	Equipotential bonding systems, industrial area	67
	Connection and bridging components	68



# Equipotential bonding systems, indoor and outdoor areas



## Basement area, VDE-tested

Type	Colour	Pack.	Weight	Item No.
		pcs	kg/100 pcs.	
<b>1801 VDE</b>	Grey	1	55,000	<b>5015 65 0</b>

**CuZn** Brass /pc.

Equipotential bonding rail for equipotential bonding according to DIN VDE 0100-410 / -540 and lightning protection equipotential bonding according to DIN VDE 0185-305

### Connection options:

- 7 single or multi-wire cables 2.5–25 mm<sup>2</sup> or fine-wire cables to 16 mm<sup>2</sup> (max. Ø 7 mm)
- 2 single or multi-wire cables 25–95 mm<sup>2</sup> or fine-wire cables to 70 mm<sup>2</sup> (max. Ø 13.5 mm)
- 1 flat conductor 30 x 3.5 mm
- According to VDE 0618, part 1
- With clamping rail 10 x 10 mm, nickel-plated brass
- With close-contact series terminals made of electrogalvanised steel
- Cover hood and rail stand made of grey polystyrene
- Lightning current carrying capacity 100 kA (10/350)
- Tension clamp with screw lock against self-loosening (e.g. required in industry and in explosion-protected areas)

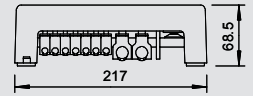

## Basement area

Type	Colour	Pack.	Weight	Item No.
		pcs	kg/100 pcs.	
<b>1809</b>	Grey	1	23,000	<b>5015 07 3</b>

**CuZn** Brass /pc.

Equipotential bonding rails for equipotential bonding to DIN VDE 0100-410 / -540 and lightning protection equipotential bonding to DIN VDE 0185-305

### Connection options:

- 7 single or multiple-core conductors to 25 mm<sup>2</sup> or fine-core conductors to 16 mm<sup>2</sup>
- 1 round conductor Rd 8-10
- 1 flat strip to FL30 or round conductor Rd 8-10
- Base plate and covering hood, polystyrene, grey
- Contact strip, nickel-plated brass
- Screws and over-piece, galvanised steel
- Capable of carrying lightning current 100 kA (10/350)

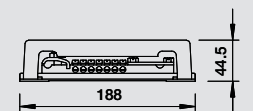

## Outdoors

Type	Colour	Pack.	Weight	Item No.
		pcs	kg/100 pcs.	
<b>1809 A</b>	Black	1	23,000	<b>5015 11 1</b>

**V2A** Stainless steel, grade 304 /pc.

### Connection options:

- 7 single or multi-core conductors to 25 mm<sup>2</sup> or fine-core conductors to 16 mm<sup>2</sup>
- 1 round conductor Rd 8-10
- 1 flat strip to FL30 or round conductor Rd 8-10
- Base plate and covering hood from polystyrene
- Colour: black, UV-resistant
- Screws and over-piece from VA
- Capable of carrying lightning current 100 kA (10/350)

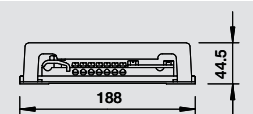

# Equipotential bonding systems, industrial area

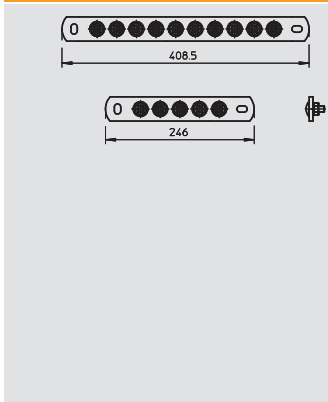

## Industrial area



Type	Number of connections	Width mm	Length mm	Height mm	Pack. pcs	Weight kg/100 pcs.	Item No.
<b>1802 5 VA</b>	5	40	246	6	1	90,000	<b>5015 85 4</b>
<b>1802 10 VA</b>	10	40	408,5	6	1	190,000	<b>5015 86 6</b>

V2A Stainless steel, grade 304 /pc.

- Main potential equalisation to VDE 0100 Part 410 and Part 540, and also lightning protection potential equalisation to VDE 0185-305 (IEC 62305)
- Insulation feet
- Quick, simple assembly of connection conductors to the contact rail using lock bolts M10
- The high-grade stainless steel versions (V2A) are suitable for outdoor use
- Complete with anchors and bolts for wall mounting
- With lock washer (DIN 137) for bolt locking against loosening (e.g. required in industry and explosion-protected areas)

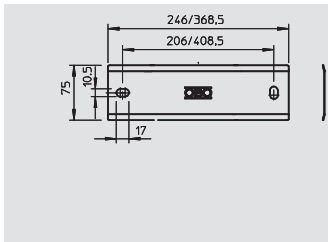

## Industrial area cover

Type	Number of connections	Pack. pcs	Weight kg/100 pcs.	Item No.
<b>1802 AH 5</b>	5	1	25,800	<b>5015 88 0</b>
<b>1802 AH 10</b>	10	1	36,300	<b>5015 88 4</b>

V2A Stainless steel, grade 304 /pc.

- Complete with all installation components

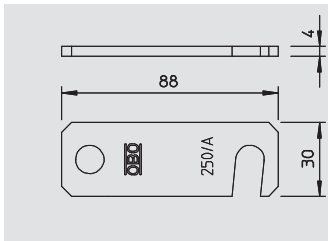

## Industrial area accessories

Type	Connection option	Pack. pcs	Weight kg/100 pcs.	Item No.
<b>1802 KL</b>	FL30	1	7,000	<b>5015 89 0</b>

V2A Stainless steel, grade 304 /pc.

- To clamp the flat conductors 30 x 3.5 and 40 x 5
- Suitable for equipotential bonding rail BigBar, type 1802



# Connection and bridging components



## Connection components – crossbar Rd 8–10 mm

Type	Fit	Pack.	Weight	Item No.
	mm	pcs	kg/100 pcs.	
<b>249 8-10 ALU-OT</b>	Rd 8-10	100	2,100	<b>5311 58 5</b>

**Al** Aluminium

- For round conductor fastening Rd 8–10
  - Suitable for M10 bolts
- Application: Equipotential bonding on PV frames

price/100 pc.

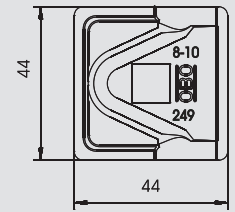

## Connection components – crossbar Rd 8–10 mm

Type	Fit	Pack.	Weight	Item No.
	mm	pcs	kg/100 pcs.	
<b>249 8-10 ST-OT</b>	Rd 8-10	100	3,240	<b>5311 50 3</b>

**St** Steel

**FT** Hot-dip galvanised

price/100 pc.

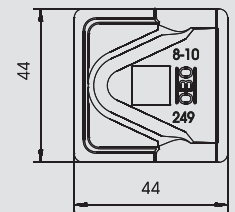

## Connection components – crossbar Rd 16 mm

Type	Fit	Pack.	Weight	Item No.
	mm	pcs	kg/100 pcs.	
<b>249 VA-OT</b>	16	100	5,700	<b>5311 57 3</b>

**V2A** Stainless steel, grade 304

- For round conductor fastening RD 16
- Suitable for M10 bolts

price/100 pc.

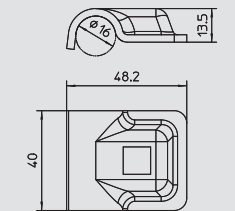

## Bridging cable

Type	Dimension L	Pack.	Weight	Item No.
	mm	pcs	kg/100 pcs.	
<b>853 300</b>	300	100	7,260	<b>5331 01 3</b>

**Cu** Copper

**Al** Aluminium

- From flexible copper cable 16 mm<sup>2</sup>
- Coating: black, chlorinated india rubber mixture
- With 1 mounting hole Ø 10.5 mm per attachment side
- With 2 mounting holes Ø 7.3 mm per attachment side
- For applications outside or inside suitable

price/100 pc.

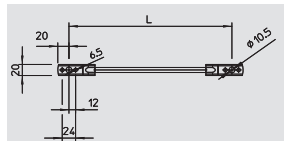

## Connection and expansion strip

Type	Pack.	Weight	Item No.
	pcs	kg/100 pcs.	
<b>856</b>	10	8,125	<b>5331 50 1</b>

**Cu** Copper

- Copper strip 35 mm<sup>2</sup>, tin-plated
- Highly-flexible with rigid ends
- Each end with mounting hole Ø 10 mm and 4 mounting holes Ø 4.3 mm

price/100 pc.

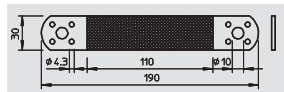

## Vario quick connector Alu

Type	Fit	Dimension A	Pack.	Weight	Item No.
	mm	mm	pcs	kg/100 pcs.	
<b>249 8-10 ALU</b>	Rd 8-10	44	30	6,600	<b>5311 51 9</b>

**Al** Aluminium

- For T, cross and parallel connectors
- Quick installation using hexagonal bolt M10 x 30, high-grade stainless steel
- Conforms to the requirements according to DIN VDE 0185-305 (IEC 62305)

price/100 pc.

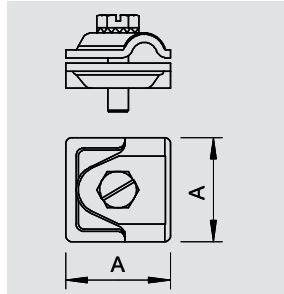

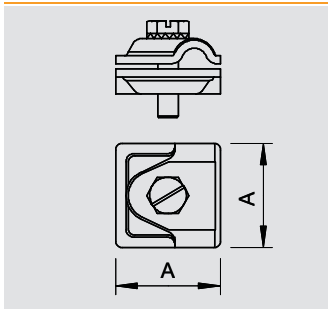

## Vario quick connector VA



Type	Fit	Dimension A	Material symbol	Pack.	Weight	Item No.
	mm	mm		pcs	kg/100 pcs.	
<b>249 8-10 VA</b>	Rd 8-10	40	V2A	50	10,700	<b>5311 55 1</b>

V2A Stainless steel, grade 304

price/100 pc.

- For T, cross and parallel connectors
- Quick installation using hexagonal bolt M10 x 30, high-grade stainless steel
- Conforms to the requirements according to DIN VDE 0185-305 (IEC 62305)

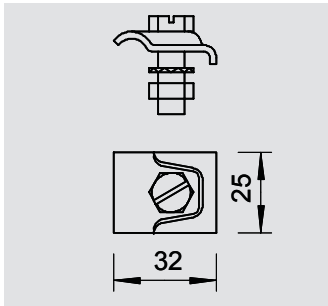

## VA terminal block

Type	Fit	Pack.	Weight	Item No.
	mm	pcs	kg/100 pcs.	
<b>324 S-VA</b>	Rd 8-10	50	3,400	<b>5326 31 1</b>

V2A Stainless steel, grade 304

price/100 pc.

- Including hexagonal bolt M8 x 25, washer and nuts

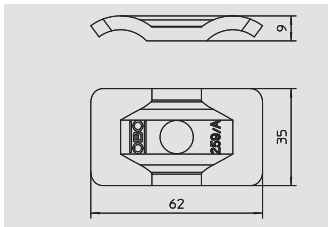

## Terminal block

Type	Fit	Pack.	Weight	Item No.
	mm	pcs	kg/100 pcs.	
<b>259 A FT 8-OT</b>	—	25	8,000	<b>5315 51 7</b>

St Steel

FT Hot-dip galvanised





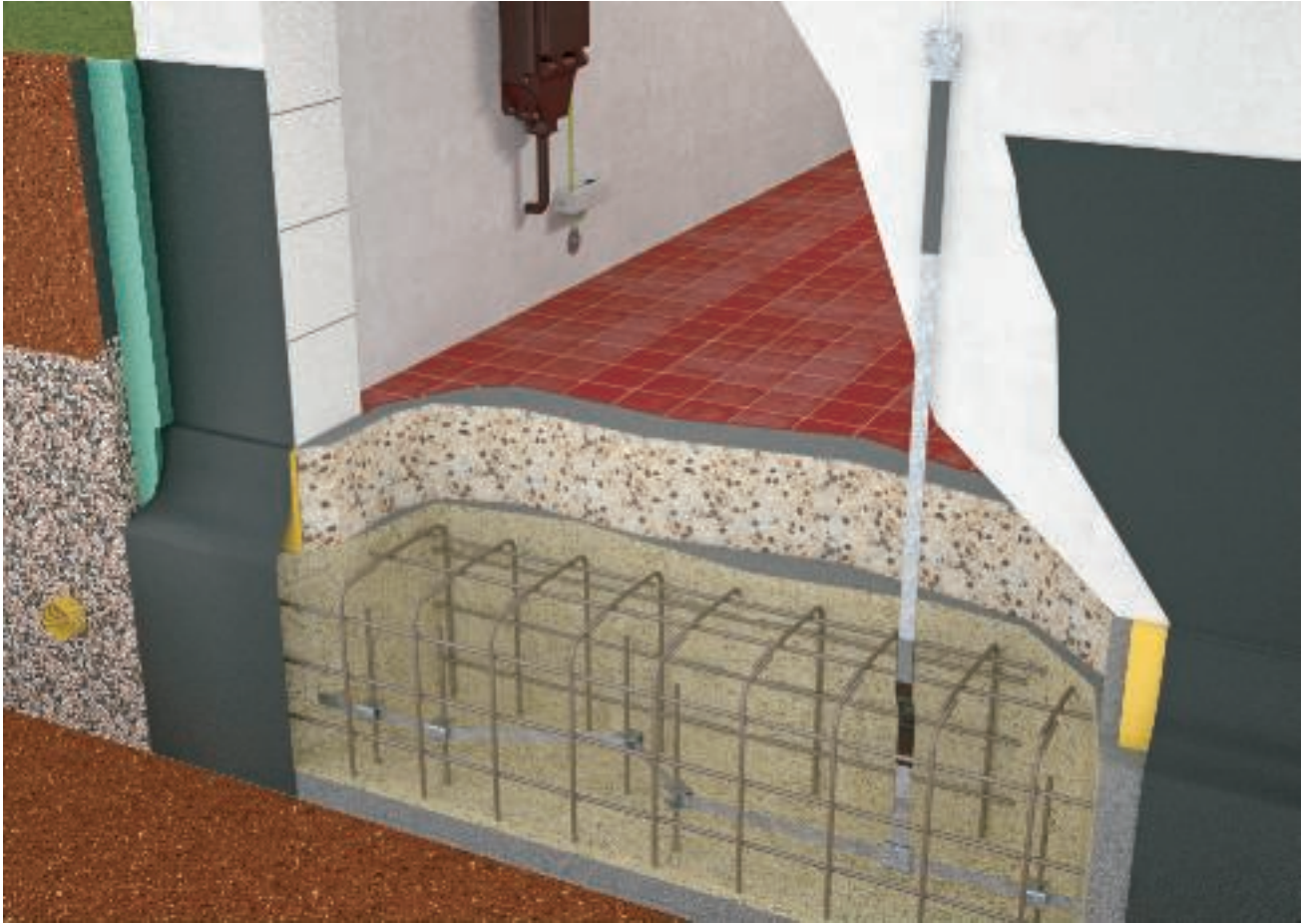

price/100 pc.







## Earthing systems

	Flat conductor	72
	Round conductor	72
	Cross-connectors	72
	Vario quick connector	72
	Connection terminal	73
	Earthing fixed point	73

# Cable material



## Galvanised steel flat conductor

Type	Dimension b x h mm	Cross- section mm <sup>2</sup>	Normal ring ca. m	Normal ring ca. kg	Weight kg/100 m	Item No.
<b>5052 DIN 30X3.5</b>	30 x 3,5	105	60	50	84,000	<b>5019 34 7</b>

**St** Steel **FT** Hot-dip galvanised price/100 m

- According to DIN EN 50164-2 (VDE 0185 Part 202)
- Meets the requirements of VDE 0185-305 (IEC 62305)
- Zinc coating: 500 g/m<sup>2</sup> (approx. 70 µm)
- For lightning protection, earthing systems and ring equipotential bonding

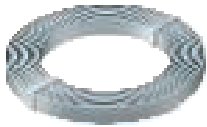
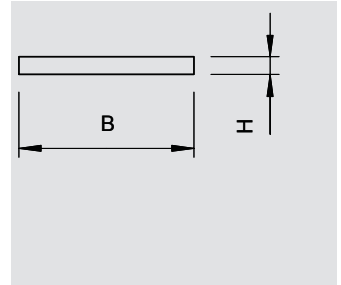

## Stainless steel flat conductor

Type	Dimension b x h mm	Cross- section mm <sup>2</sup>	Normal ring ca. m	Normal ring ca. kg	Weight kg/100 m	Item No.
<b>5052 V4A 30X3.5</b>	30 x 3,5	105	50	42	82,425	<b>5018 70 6</b>

**V4A** Stainless steel, grade 316 Ti price/100 m

- According to DIN EN 50164-2 (VDE 0185 Part 202)
- Corresponds to the requirements of VDE 0185-305 (IEC 62305)
- According to the foundation earther standard DIN 18014, V4A is required in the earth
- For use in areas at risk of corrosion
- For lightning protection, earthing systems and ring equipotential bonding

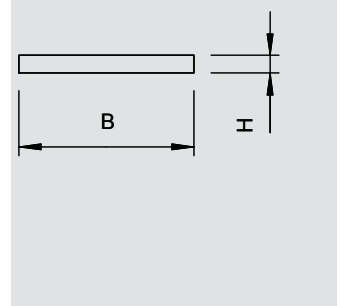

## Round conductor, galvanised steel

Type	Material symbol	Inter- face	Nominal size Ø mm	Cross- section mm <sup>2</sup>	Normal ring ca. m	Normal ring ca. kg	Weight kg/100 m	Item No.
<b>RD 10</b>	St	FT	10	78	80	50	63,000	<b>5021 10 3</b>

**St** Steel **FT** Hot-dip galvanised price/100 m

- According to DIN EN 50164-2 (VDE 0185 part 202)
- Conforms to the requirements according to DIN VDE 0185-305 (IEC 62305)
- RD 10 can also be used in earth
- Zinc coating: 350 g/m<sup>2</sup> (approx. 50 µm)

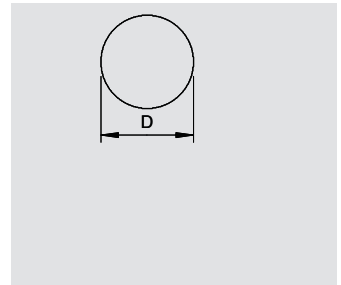

## Round conductor, stainless steel

Type	Nominal size Ø mm	Cross- section mm <sup>2</sup>	Normal ring ca. m	Normal ring ca. kg	Weight kg/100 m	Item No.
<b>RD 10-V4A</b>	10	78	80	50	63,000	<b>5021 64 7</b>

**V4A** Stainless steel, grade 316 Ti price/100 m

- According to DIN EN 50164-2 (VDE 0185 Part 202)
- Corresponds to the requirements of VDE 0185-305 (IEC 62305)
- RD 10-V4A for applications in the earth
- According to the foundation earther standard DIN 18014, V4A is required in the earth

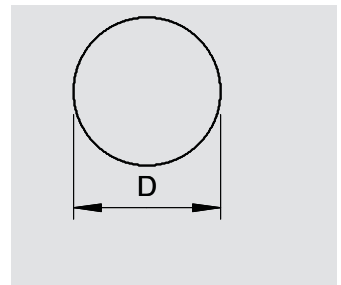

## Cross-connectors

Type	Fit mm	Pack. pcs	Weight kg/100 pcs.	Item No.
<b>250 V4A</b>	Rd 8-10/FL30	25	10,260	<b>5312 92 5</b>

**V4A** Stainless steel, grade 316 Ti price/100 pc.

- Fit: Rd 8-10 x Rd 8-10
- Fit: Rd 8-10 x FL 30
- Fit: FL 30 x FL 30
- Installed with 2 hexagonal bolts M8 x 20 (F)

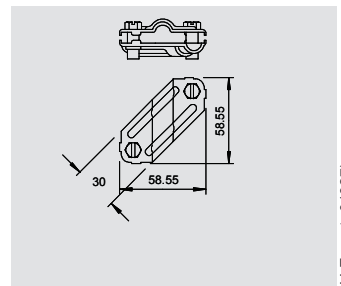

## Vario quick connector

Type	Fit mm	Dimen- sion A mm	Material symbol	Pack. pcs	Weight kg/100 pcs.	Item No.
<b>249 8-10 VA</b>	Rd 8-10	40	V2A	50	10,700	<b>5311 55 1</b>

**V2A** Stainless steel, grade 304 price/100 pc.

- For T, cross and parallel connectors
- Quick installation using hexagonal bolt M10 x 30, high-grade stainless steel
- Conforms to the requirements according to DIN VDE 0185-305 (IEC 62305)

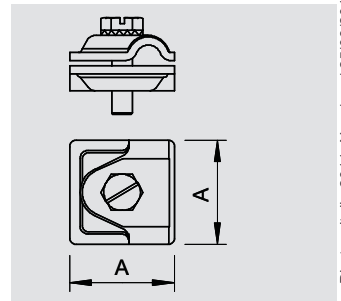

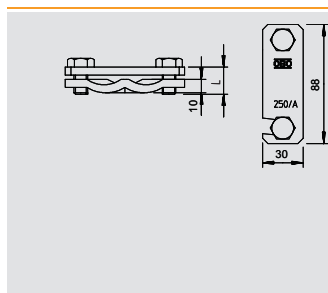

## Diagonal clamp

Type	Dimension L mm	Fit mm	Pack. pcs	Weight kg/100 pcs.	Item No.
<b>250 A-VA</b>	40	Rd 6-22/max. FL50	25	28,800	<b>5313 02 3</b>

V2A Stainless steel, grade 304

price/100 pc.

- For reinforced steels Ø 6-22 mm and flat conductor 50 x 4
- Installed with screws M10 x 40
- AS version with screws M10 x 20
- Simple installation with open slot

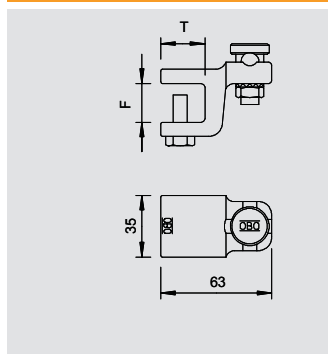

## Connection terminal

Type	Fit mm	Dimension T mm	Dimension L mm	Clamping area mm	Pack. pcs	Weight kg/100 pcs.	Item No.
<b>5004 DIN-FT 12</b>	Rd 8-10	20	55	max. 12	25	18,730	<b>5304 40 7</b>
<b>5004 DIN-FT 20</b>	Rd 8-10	25	63	10-20	25	30,600	<b>5304 50 4</b>

TG Cast iron FT Hot-dip galvanised

price/100 pc.

- Flange thickness to 12 or 10-20 mm
- With pre-mounted Fix-Kontakt clamping screw 5000
- 2 hexagonal bolts M8 x 20, screws made of hot galvanised steel,
- Terminal block made of malleable iron, hot galvanised
- Mounting of the round conductors either vertical or transverse to structure
- Corresponds to the requirements of DIN VDE 0185-305-3

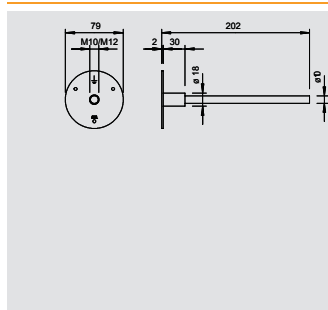

## Earthing fixed point

Type	Thread	Pack. pcs	Weight kg/100 pcs.	Item No.
<b>205 B-M10 VA</b>	M10	25	25,500	<b>5420 00 8</b>
<b>205 B-M12 VA</b>	M12	25	25,500	<b>5420 01 6</b>

V4A Stainless steel, grade 316 L

/pc.

- Connection to earthing systems, arrestors and reinforcement
- Contact plate: Ø 79 mm, made of rustproof stainless steel (V4A)
- Clamping bolt Ø 10 mm, rustproof (V2A)
- Incl. plastic cover for simple installation

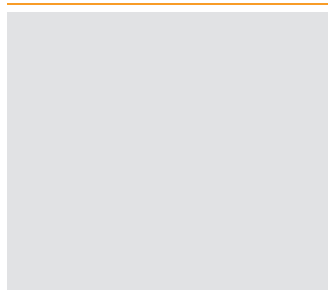

## Plastic corrosion protection strip

Type	Width mm	Length m	Pack. pcs	Weight kg/100 pcs.	Item No.
<b>356 50</b>	50	10	1	71,500	<b>2360 05 5</b>
<b>356 100</b>	100	10	1	122,200	<b>2360 10 1</b>

Petrolatum

/pc.

- Approx. 1.1 mm thick
- Width: 50 mm or 100 mm, made of petrolatum-coated chemical fibre fabric
- Can be processed cold

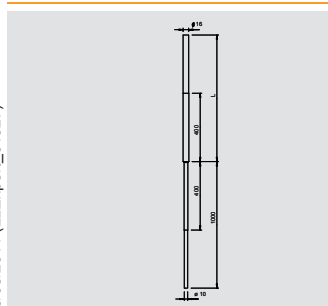

## Earth entry rod, tapered and partially insulated

Type	Material symbol	Inter-face	Length mm	Nominal size Ø mm	Pack. pcs	Weight kg/100 pcs.	Item No.
<b>204 KS-2000</b>	St	F	2000	16/10	1	230,000	<b>5430 01 1</b>
<b>204 KS-2500</b>	St	F	2500	16/10	1	310,000	<b>5430 06 2</b>

St Steel F Hot-dip galvanised

/pc.









- 16 mm earth entry with 10 mm connection
- With mounted heat-shrinkable sleeve (corrosion protection)

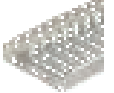





## Cable routing

	Mesh cable tray systems	76
	Cable tray systems	83
	Vertical ladder systems	87
	Mounting systems	88
	Wall and ceiling duct	95
	Cable and pipe fastening systems, plastic	101
	Cable and pipe fastening systems, metal	103
	Pipe systems	105
	Junction box systems	108
	Cable gland systems, plastic	111

# Mesh cable tray systems



## Mesh cable tray GR-Magic®

Type	Width mm	Wire Ø mm	Length mm	Useful cross-section cm <sup>2</sup>	Weight kg/100 m	Item No.
GRM 35 50 FT	50	3,9	3000	17,5	46,300	6000 06 9
GRM 35 100 FT	100	3,9	3000	35	50,400	6000 07 1
GRM 35 150 FT	150	3,9	3000	52,5	64,500	6000 07 2
GRM 35 200 FT	200	3,9	3000	70	78,600	6000 07 3
GRM 35 300 FT	300	4,8	3000	105	162,700	6000 07 5
GRM 35 50VA4301	50	3,9	3000	17,5	45,000	6000 05 4
GRM 35 100VA4301	100	3,9	3000	35	49,000	6000 05 5
GRM 35 150VA4301	150	3,9	3000	52,5	62,600	6000 05 6
GRM 35 200VA4301	200	3,9	3000	70	76,300	6000 05 7
GRM 35 300VA4301	300	4,8	3000	105	157,900	6000 05 9

St Steel    V2A Stainless steel, grade 304    FT Hot-dip galvanised    /m

Mesh cable tray with shaped connector of side height 35 mm.

Magnetic shield insulation without cover 15 dB, with cover 25 dB.

No additional connection components are required for the mesh cable tray, it is simply interlocked. The grid width is 50 x 100 mm.

### Load diagram, GR-Magic mesh cable tray, type GRM 35

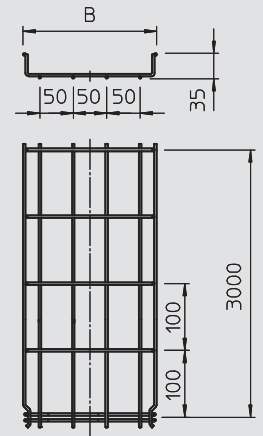
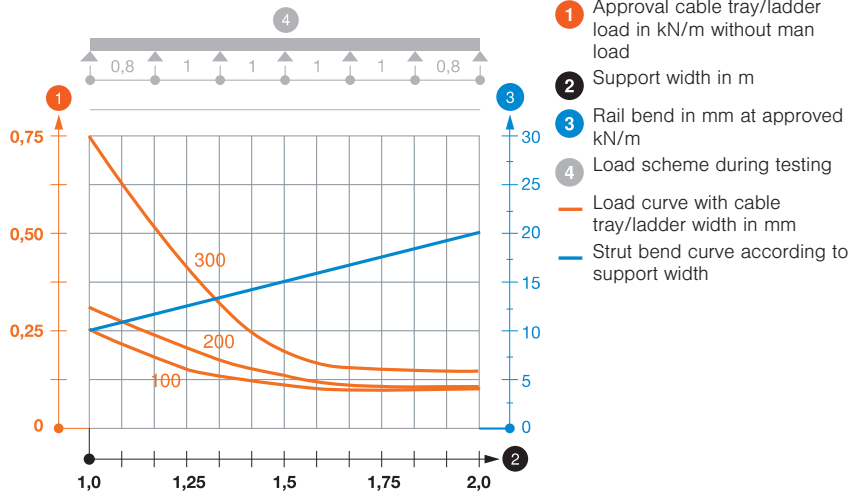

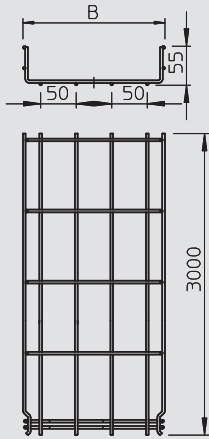

## Mesh cable tray GR-Magic®



Type	Width mm	Wire Ø mm	Length mm	Useful cross-section cm <sup>2</sup>	Weight kg/100 m	Item No.
GRM 55 50 FT	50	3,9	3000	16	70,000	6001 41 5
GRM 55 100 FT	100	3,9	3000	40	71,330	6001 41 6
GRM 55 150 FT	150	3,9	3000	63	89,900	6001 41 8
GRM 55 200 FT	200	3,9	3000	87	103,500	6001 42 0
GRM 55 200 4.8FT	200	4,8	3000	87	154,300	6001 42 1
GRM 55 300 FT	300	4,8	3000	129	198,800	6001 42 4
GRM 55 400 FT	400	4,8	3000	175	244,300	6001 42 8
GRM 55 450 FT	450	4,8	3000	195	248,300	6001 43 0
GRM 55 500 FT	500	4,8	3000	220	287,900	6001 43 2
GRM 55 600 FT	600	4,8	3000	265	331,600	6001 43 6

**St** Steel **FT** Hot-dip galvanised /m

Mesh cable tray with shaped connector of side height 55 mm.

Magnetic shield insulation without cover 15 dB, with cover 25 dB.

No additional connection components are required for the mesh cable tray, it is simply interlocked. The grid width is 50 x 100 mm (exception: GRM 55/50 = 20 x 100 mm).

### Load diagram, GR-Magic mesh cable tray, type GRM 55

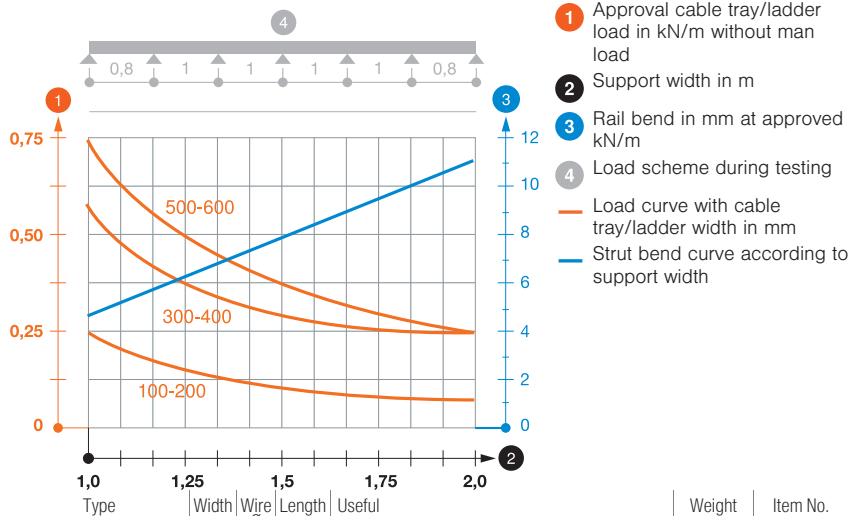

- 1 Approval cable tray/ladder load in kN/m without man load
- 2 Support width in m
- 3 Rail bend in mm at approved kN/m
- 4 Load scheme during testing
- Load curve with cable tray/ladder width in mm
- Strut bend curve according to support width

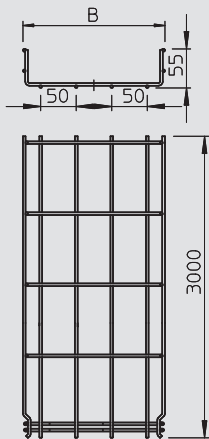

Type	Width mm	Wire Ø mm	Length mm	Useful cross-section cm <sup>2</sup>	Weight kg/100 m	Item No.
GRM 55 50VA4301	50	3,9	3000	16	67,000	6001 07 0
GRM 55 100VA4301	100	3,9	3000	40	72,700	6001 07 2
GRM 55 150VA4301	150	3,9	3000	63	88,000	6001 07 4
GRM 55 200VA4301	200	3,9	3000	87	97,000	6001 07 6
GRM 55 300VA4301	300	4,8	3000	129	191,100	6001 07 8
GRM 55 400VA4301	400	4,8	3000	175	243,000	6001 08 0
GRM 55 500VA4301	500	4,8	3000	220	287,000	6001 08 2
GRM 55 600VA4301	600	4,8	3000	265	331,000	6001 08 5

**V2A** Stainless steel, grade 304 **Stained** /m

Mesh cable tray with shaped connector of side height 55 mm.

Magnetic shield insulation without cover 15 dB, with cover 25 dB.

No additional connection components are required for the mesh cable tray, it is simply interlocked. The grid width is 50 x 100 mm (exception: GRM 55/50 = 20 x 100 mm).

### Load diagram, mesh cable tray GRM 55 VA

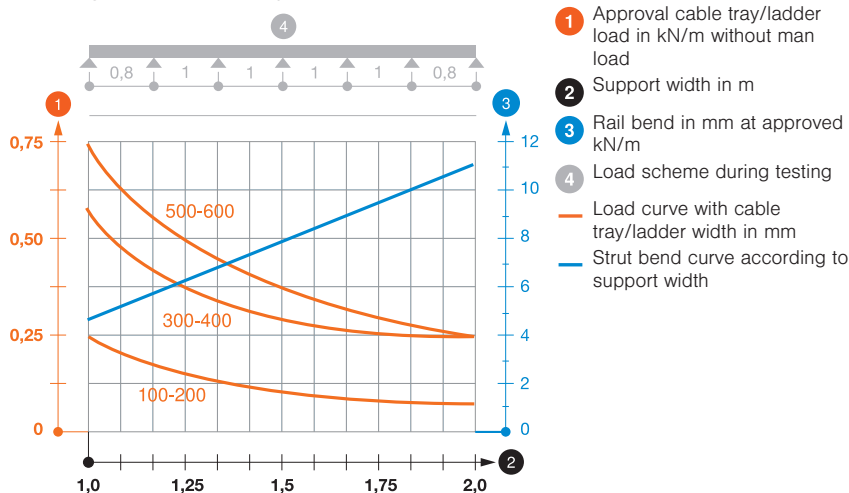

- 1 Approval cable tray/ladder load in kN/m without man load
- 2 Support width in m
- 3 Rail bend in mm at approved kN/m
- 4 Load scheme during testing
- Load curve with cable tray/ladder width in mm
- Strut bend curve according to support width

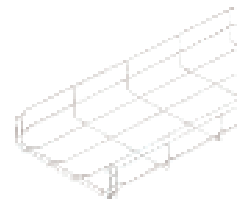

# Mesh cable tray systems



## Mesh cable tray GR-Magic®

Type	Width mm	Wire Ø mm	Length mm	Useful cross- section cm <sup>2</sup>	Weight kg/100 m	Item No.
GRM 105 100 FT	100	3,9	3000	82	103,700	6002 43 1
GRM 105 150 FT	150	3,9	3000	130	116,000	6002 43 3
GRM 105 200 FT	200	4,8	3000	175	200,700	6002 43 5
GRM 105 300 FT	300	4,8	3000	268	244,000	6002 43 7
GRM 105 400 FT	400	4,8	3000	363	287,700	6002 43 9
GRM 105 450 FT	450	4,8	3000	411	309,700	6002 44 1
GRM 105 500 FT	500	4,8	3000	459	333,000	6002 44 3
GRM 105 600 FT	600	4,8	3000	554	375,000	6002 44 5

**St** Steel      **FT** Hot-dip galvanised      /m

Mesh cable tray with shaped connector of side height 105 mm.

Magnetic shield insulation without cover 15 dB, with cover 25 dB.

No additional connection components are required for the mesh cable tray, it is simply inter-locked. The grid width is 50 x 100 mm.

### Load diagram, mesh cable tray, type GR 105

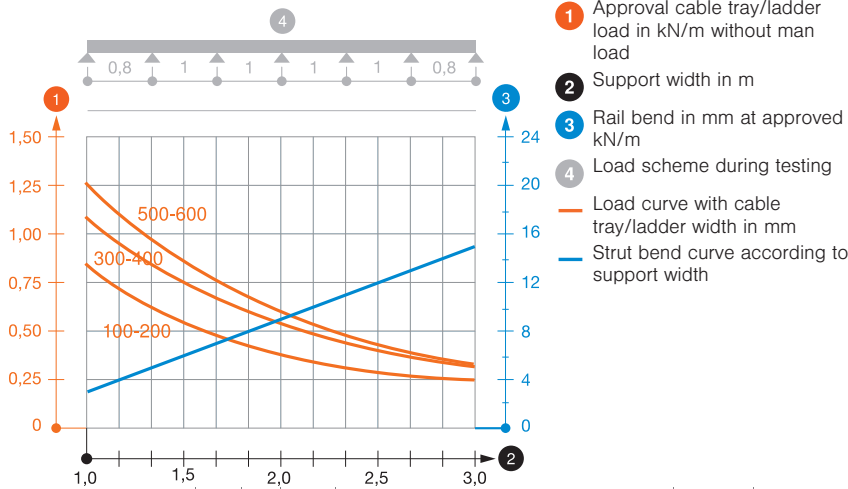

Type	Width mm	Wire Ø mm	Length mm	Useful cross- section cm <sup>2</sup>	Weight kg/100 m	Item No.
GRM105 100VA4301	100	3,9	3000	82	99,000	6002 45 1
GRM105 200VA4301	200	4,8	3000	175	193,000	6002 45 7
GRM105 300VA4301	300	4,8	3000	268	235,000	6002 46 0
GRM105 400VA4301	400	4,8	3000	363	277,000	6002 46 3
GRM105 500VA4301	500	4,8	3000	459	319,100	6002 46 6

**V2A** Stainless steel, grade 304      Stained      /m

Mesh cable tray with shaped connector of side height 105 mm.

Magnetic shield insulation without cover 15 dB, with cover 25 dB.

No additional connection components are required for the mesh cable tray, it is simply inter-locked. The grid width is 50 x 100 mm.

### Load diagram, mesh cable tray, type GRM 105

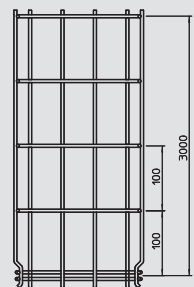
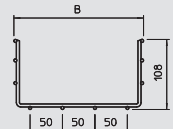
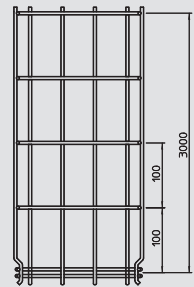
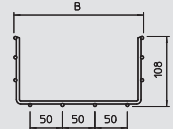
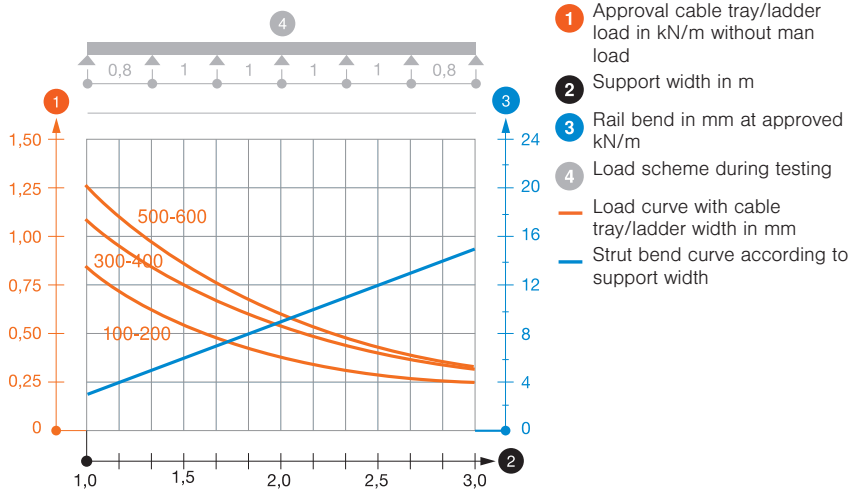



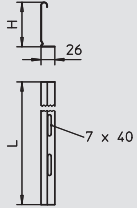
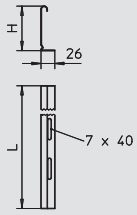

## Separating retainer

Type	Dimension H mm	Dimension L mm	Pack. m	Weight kg/100 m	Item No.
<b>TSG 30 DD</b>	30	3000	45	38,000	<b>6062 31 4</b>
<b>TSG 30 VA4301</b>	30	3000	45	38,000	<b>6062 05 2</b>

**St** Steel    **V2A** Stainless steel, grade 304    **DD** Zinc-aluminium coated, double-dip /m

Barrier strip for separation of cables of different voltages or functions.

Type	Dimension H mm	Dimension L mm	Pack. m	Weight kg/100 m	Item No.
<b>TSG 85 DD</b>	85	3000	45	70,300	<b>6062 33 1</b>
<b>TSG 85 VA4301</b>	85	3000	45	70,300	<b>6062 17 3</b>

**St** Steel    **V2A** Stainless steel, grade 304    **DD** Zinc-aluminium coated, double-dip /m

Barrier strip for separation of cables of different voltages or functions.

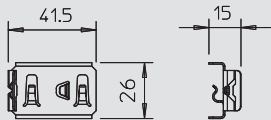

## Clamping piece for separating retainer fastening

Type	Pack. pcs	Weight kg/100 pcs.	Item No.
<b>KS GR VA4310</b>	30	0,830	<b>6062 28 2</b>

**V2A** Stainless steel, grade 301 price/100 pc.

Clamping piece for fastening barrier strips in mesh cable trays.



## Connector for separating retainer

Type	Pack. pcs	Weight kg/100 pcs.	Item No.
<b>TSGV VA4310</b>	10	1,000	<b>6067 97 0</b>

**V2A** Stainless steel, grade 301 /pc.

Barrier strip connector for screwless connection of the TSG barrier strip in all side heights.

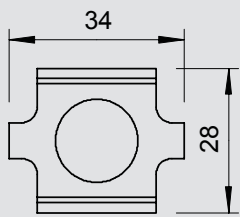

## Joint connector

Type	Pack. pcs	Weight kg/100 pcs.	Item No.
<b>GSV 34 FT</b>	25	3,000	<b>6016 63 4</b>

**St** Steel    **FT** Hot-dip galvanised /pc.

Screwed version of joint connector for mesh cable trays. Including FRS M6 x 20 bolt with nut-and-washer assembly.

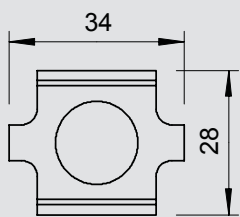
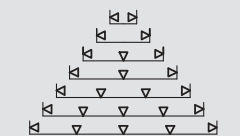

Type	Pack. pcs	Weight kg/100 pcs.	Item No.
<b>GSV 34 VA4301</b>	25	3,000	<b>6016 64 2</b>

**V2A** Stainless steel, grade 304 /pc.

Screwed version of joint connector for mesh cable trays. Including screw of type FRS M6 x 20.



# Mesh cable tray systems



## Quick connector

Type	Width	Pack.	Weight	Item No.
	mm	pcs	kg/100 pcs.	
<b>GRV 245 DD</b>	245	50	13,500	<b>6016 68 4</b>
<b>GRV 245 VA4404</b>	245	50	13,500	<b>6016 68 8</b>

**St** Steel    **V4A** Stainless steel, grade 316 L    **DD** Zinc-aluminium coated, double-dip /pc.

Long mesh cable tray connection for screwless straight connection of mesh cable trays.  
Two straight connectors, type GRV 245, are used for each connection point.

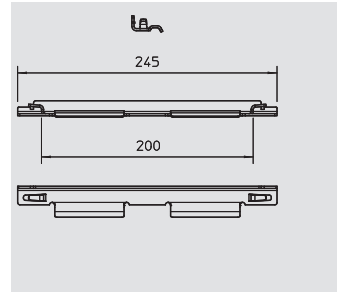

## Clamping piece

Type	Pack.	Weight	Item No.
	pcs	kg/100 pcs.	
<b>GKS 34 FT</b>	100	2,000	<b>6016 82 0</b>
<b>GKS 34 VA4301</b>	100	2,000	<b>6016 83 9</b>

**St** Steel    **V2A** Stainless steel, grade 304    **FT** Hot-dip galvanised /pc.

Clamp for fastening mesh cable trays to wall or support brackets.  
Including FRS M6 x 20 bolt with nut-and-washer assembly.

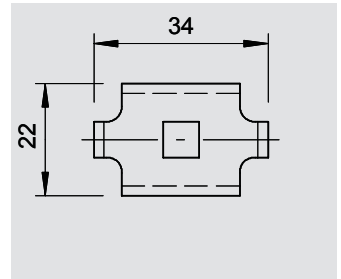

## Clamping piece

Type	Pack.	Weight	Item No.
	pcs	kg/100 pcs.	
<b>GKB 34 VA</b>	50	1,000	<b>6016 67 6</b>

**V2A** Stainless steel, grade 304 /pc.

Clamping piece for fastening mesh cable trays of width 50 mm to the floor.

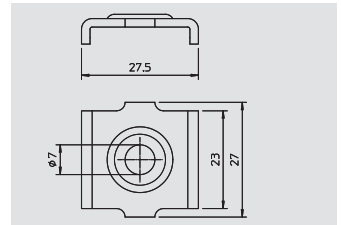

## Clamping piece

Type	Pack.	Weight	Item No.
	pcs	kg/100 pcs.	
<b>GKT 38 FT</b>	100	2,400	<b>6017 06 1</b>
<b>GKT 38 VA4301</b>	100	2,200	<b>6017 04 5</b>

**St** Steel    **V2A** Stainless steel, grade 304    **FT** Hot-dip galvanised /pc.

Clamping piece for fastening barrier strip in mesh cable trays.  
Including FRS M6 x 20 bolt with nut-and-washer assembly.

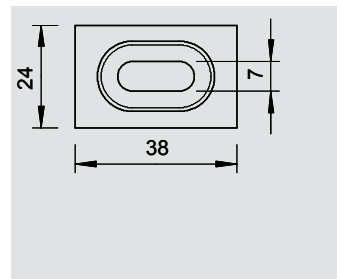

## Earthing clip

Type	Shipping box	Pack.	Weight	Item No.
	pcs	pcs	kg/100 pcs.	
<b>939</b>	150	25	5,932	<b>5043 10 7</b>

**St** Steel    **G** Electrogalvanised price/100 pc.

- For cables to 16 mm<sup>2</sup> and flat conductors
- Fit: cable to 16 mm<sup>2</sup> x max. FL 30
- With riveted brass connection terminal and one cylinder bolt, M5 x 12, with two cylinder bolts, M6 x 16

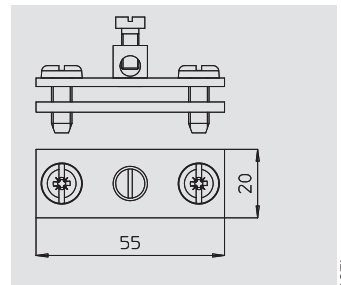

## Earthing screw

Type	Dimension L	Dimension I	Cross-section	SW	Thread	Pack.	Weight	Item No.
	mm	mm	mm <sup>2</sup>	mm		pcs	kg/100 pcs.	
<b>B 33020</b>	22	8	25	18	M6	50	3,100	<b>6404 00 6</b>
<b>B 33021</b>	26	10	35	21	M6	50	4,800	<b>6404 01 4</b>

**CuZn** Brass    Bright price/100 pc.

Earthing screw for fastening the equipotential bonding wire to the cable support system.

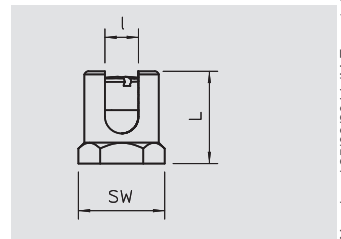

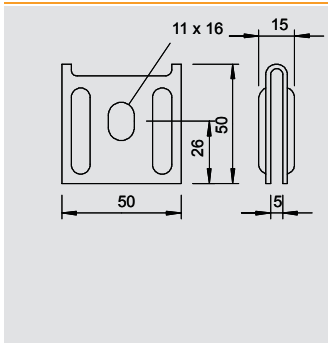

## Wall and floor fastener

Type	Pack.	Weight	Item No.
	pcs	kg/100 pcs.	
<b>K12 1818 VA4301</b>	25	7,600	<b>6016 42 1</b>

V2A Stainless steel, grade 304

/pc.

Wall and floor fastener for mesh cable trays.

Recommendation:

As wall mounting up to max. mesh cable tray width 200 mm.

As centre suspension up to max. mesh cable tray width 200 mm.

As a trapeze suspension from a width of 300 mm.

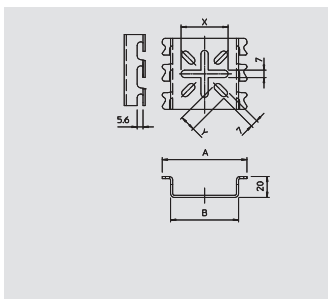

## Mounting plate

Type	Dimension A	Dimension B	Dimension x	Dimension y	Pack.	Weight	Item No.
	mm	mm	mm	mm	pcs	kg/100 pcs.	
<b>MPG 65 FT</b>	81	65	45	15	30	9,200	<b>6006 48 6</b>
<b>MPG 90 FT</b>	111	95	45	38	30	16,800	<b>6006 48 7</b>
<b>MPG 65 VA4404</b>	81	65	45	15	30	8,800	<b>6006 48 8</b>
<b>MPG 90 VA4404</b>	111	95	45	38	30	16,100	<b>6006 48 9</b>

St Steel V4A Stainless steel, grade 316 L FT Hot-dip galvanised /pc.

Mounting for screwless fastening on mesh cable trays.

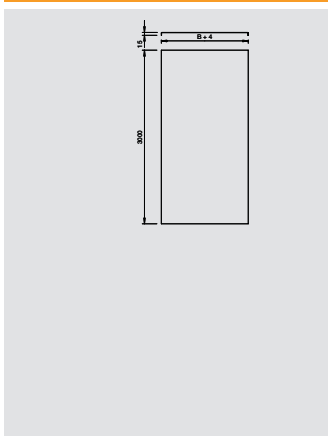

## Unperforated cover

Type	Width	Plate thickness	Length	Weight	Item No.
	mm	mm	mm	kg/100 m	
<b>DRLU 050 VA4301</b>	50	1	3000	60,000	<b>6052 82 1</b>
<b>DRLU 100 VA4301</b>	100	1	3000	104,000	<b>6052 82 4</b>
<b>DRLU 150 VA4301</b>	150	1	3000	138,200	<b>6052 82 8</b>
<b>DRLU 200 VA4301</b>	200	1	3000	178,000	<b>6052 83 1</b>
<b>DRLU 300 VA4301</b>	300	1	3000	256,000	<b>6052 83 4</b>
<b>DRLU 400 VA4301</b>	400	1	3000	334,300	<b>6052 83 7</b>
<b>DRLU 500 VA4301</b>	500	1,25	3000	516,100	<b>6052 84 1</b>
<b>DRLU 600 VA4301</b>	600	1,25	3000	614,300	<b>6052 84 4</b>

V2A Stainless steel, grade 304

/m

Cover for cable trays and mesh cable trays.

Take appropriate constructive protection measures if there are high wind speeds.

Cross beading from 500 mm width.

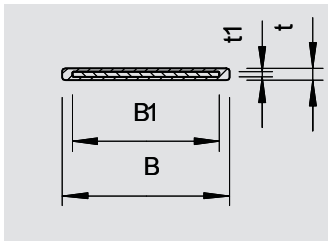

## Tightening strap for cover fastening

Type	Dimension	Minimum breaking load kN	Colour	Shipping box	Pack.	Weight	Item No.
	mm			m	m	kg/100 m	
<b>574 03 SW</b>	17 x 1.0	2,25	Black	250	25	6,950	<b>6490 02 6</b>

V2A Stainless steel, grade 301

price/100 m

Tightening strap made of rustproof steel and with plastic covering for fastening on cable trays and ladders.

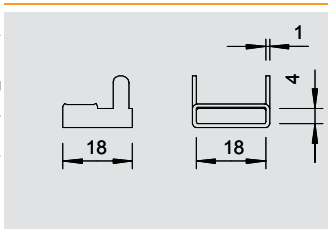

## Tightening strap lock

Type	Shipping box	Pack.	Weight	Item No.
	pcs	pcs	kg/100 pcs.	
<b>197 VA4301</b>	1800	100	0,560	<b>6490 96 4</b>

V2A Stainless steel, grade 304

price/100 pc.

Tightening strap lock for single-sided locking of tightening strap in problematic areas.

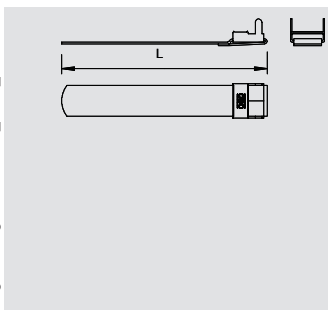

## Tightening strap in fixed lengths

Type	Dimension	Length	Colour	Shipping box	Pack.	Weight	Item No.
	mm	mm		pcs	pcs	kg/100 pcs.	
<b>574 03 30 BA</b>	17 x 1.0	300	Blue anthracite	500	25	2,410	<b>6490 10 7</b>
<b>574 03 45 BA</b>	17 x 1.0	450	Blue anthracite	250	25	3,260	<b>6490 12 3</b>
<b>574 05 55 GNBG</b>	16.5 x 1.2	550	Green-beige	250	25	4,660	<b>6490 15 8</b>
<b>574 05 65 GNBG</b>	16.5 x 1.2	650	Green-beige	250	25	5,370	<b>6490 17 4</b>

V2A Stainless steel, grade 301

price/100 pc.

Tightening strap, 574/03/VA and 574/05/VA, completely preterminated with tightening strap lock.



# Mesh cable tray systems



## Spring chuck

Type	Pack.	Weight	Item No.
	pcs	kg/100 pcs.	
<b>575</b>	1	29,700	<b>6498 01 9</b>

**St** Steel /pc.

For tightening strap 574/...  
 Mounting of the tightening strap:  
 1. Cut the strap to the right length, push it through the lock and turn it over.  
 2. Loop the strap around the cable, push the loose end through the lock.  
 3. Tighten the end of the strap with the pliers.  
 4. Turn the end of the taut strap with the pliers. Remove the pliers.  
 5. Complete turnover the turned end of the strap with the hammer, secure the end of the strap by hitting the two standing lobes of the lock.

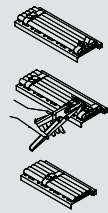

## Cover clamp

Type	Pack.	Weight	Item No.
	pcs	kg/100 pcs.	
<b>DKU 60 VA4310</b>	60	0,800	<b>6065 60 0</b>
<b>DKU 120 VA4310</b>	120	0,800	<b>6065 61 0</b>

**V2A** Stainless steel, grade 301 price/100 pc.  
 Cover clamp for universal fastening of covers on cable trays, mesh cable trays and AZ small ducts.  
 Depending on the tray width, 4–6 cover clamps are required for secure fastening of a 3 m cover.

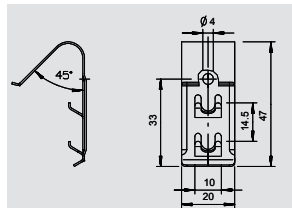

## Stand – FangFix system 16 kg

Type	Nominal size Ø	Pack.	Weight	Item No.
	mm	pcs	kg/100 pcs.	
<b>F-FIX-S16</b>	365	1	1700,000	<b>5403 22 7</b>

price/100 pc.

- 16 kg stone of Ø 365 mm, high level of stability
- Concrete, frost-resistant
- Stackable



Type	Nominal size Ø	Pack.	Weight	Item No.
	mm	pcs	kg/100 pcs.	
<b>F-FIX-B16</b>	365	10	12,600	<b>5403 23 5</b>

**PP** Polypropylene price/100 pc.

Edge protection with integrated dowel (basic) suitable for FangFix system.

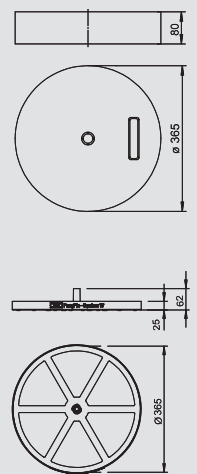

## Stand – FangFix system 10 kg

Type	Nominal size Ø	Pack.	Weight	Item No.
	mm	pcs	kg/100 pcs.	
<b>F-FIX-S10</b>	289	1	1000,000	<b>5403 11 7</b>

price/100 pc.

- 10 kg stone of Ø 289 mm, high level of stability
- Concrete, frost-resistant
- Stackable



Type	Nominal size Ø	Pack.	Weight	Item No.
	mm	pcs	kg/100 pcs.	
<b>F-FIX-B10</b>	295	10	5,800	<b>5403 12 4</b>

**PP** Polypropylene price/100 pc.

Edge protection with integrated dowel (basic) suitable for FangFix 10 system.

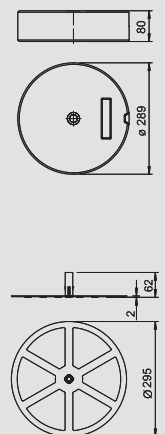

## Mounting adapter for mesh cable trays on stand systems

Type	Dimension	Scope of delivery:	Pack.	Weight	Item No.
			pcs	kg/100 pcs.	
<b>TrayFix</b>	ø20mm	Retaining plate with fastening plug for FangFix	25	9,850	<b>5403 10 0</b>

price/100 pc.

Mounting system for fastening mesh cable trays on FangFix blocks of 10 or 16 kg for cable routing on flat roofs.  
 Minimum width of the mesh cable tray: 100 mm.

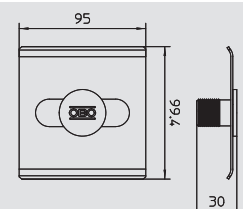

## RKSM cable tray

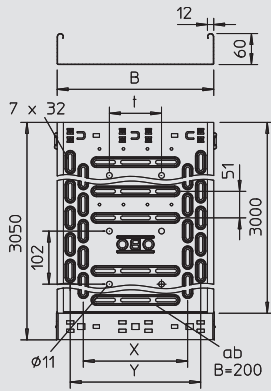

Type	Width mm	Plate thickness mm	Length mm	Useful cross- section cm <sup>2</sup>	Dimen- sion x mm	Dimen- sion y mm	Dimen- sion t mm	Weight kg/100 m	Item No.
<b>RKSM 610 VA4301</b>	100	0,75	3050	58	—	50	—	134,300	<b>6047 61 3</b>
<b>RKSM 615 VA4301</b>	150	0,75	3050	88	50	100	—	157,700	<b>6047 63 2</b>
<b>RKSM 620 VA4301</b>	200	0,75	3050	118	100	150	—	183,000	<b>6047 64 0</b>
<b>RKSM 630 VA4301</b>	300	0,75	3050	178	200	250	100	239,000	<b>6047 65 6</b>
<b>RKSM 640 VA4301</b>	400	0,9	3050	238	300	350	200	331,300	<b>6047 69 1</b>
<b>RKSM 650 VA4301</b>	500	0,9	3050	298	400	450	300	392,300	<b>6047 72 1</b>
<b>RKSM 660 VA4301</b>	600	0,9	3050	358	450	550	400	453,330	<b>6047 73 7</b>

V2A Stainless steel, grade 304 Stained /m

RKSM 60 = efficient magic cable tray system with 60 mm side height.

Magnetic shield insulation without cover 20 dB, with cover 50 dB.

Cable tray with quick connection system, including all the relevant connection components for time-saving and economic installation, with beaded straight base perforation, 7 x 20 mm, for bracket mounting and, from the width 200 mm, with 7 x 32 mm transverse beading for cable ventilation and simplified mounting. With 11 mm perforation for direct threaded rod suspension. Continuous side perforation, 7 x 20 mm, as connector perforation.

The stock length is 60 mm, the usable length when combined is 60 mm.

The spring element FED 60 can be ordered separately as a accessory part (spare) for the cable tray RKS-Magic with a side height of 60 mm under the article number 6068859.

The continuous equipotential bonding is guaranteed without additional components.

### Load diagram, cable tray, type RKSM 60

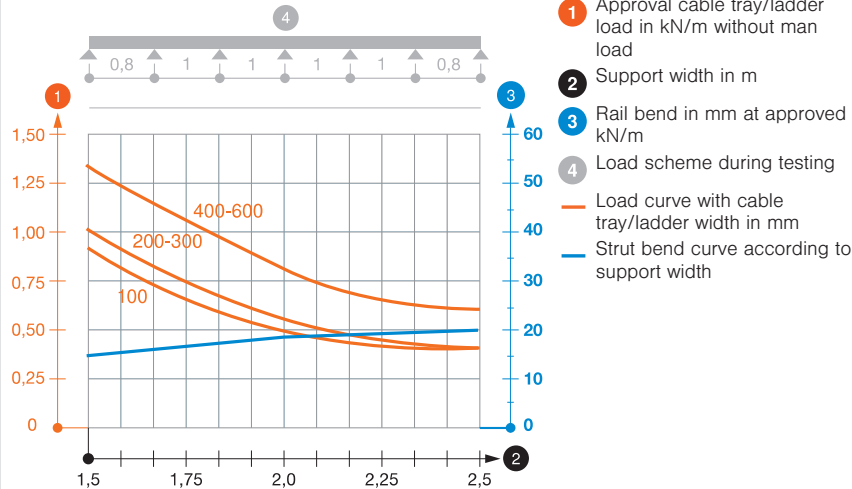



# Cable tray systems



## MKS cable tray

Type	Width mm	Plate thickness mm	Length mm	Useful cross- section cm <sup>2</sup>	Weight kg/100 m	Item No.
<b>MKSU 610 VA4301</b>	100	0,8	3000	58	154,000	<b>6063 77 2</b>
<b>MKSU 620 VA4301</b>	200	0,8	3000	118	217,000	<b>6063 78 0</b>
<b>MKSU 630 VA4301</b>	300	0,8	3000	178	280,000	<b>6063 79 9</b>
<b>MKSU 640 VA4301</b>	400	1	3000	238	426,000	<b>6063 84 5</b>
<b>MKSU 650 VA4301</b>	500	1	3000	298	520,000	<b>6063 86 1</b>
<b>MKSU 660 VA4301</b>	600	1	3000	358	601,000	<b>6063 88 8</b>

V2A Stainless steel, grade 304 /m

MKSU 60 = Medium-duty cable tray system, unperforated, with a side height of 60 mm.

Magnetic shield insulation without cover 20 dB, with cover 50 dB.

The cable tray has connector perforations on both sides.

Connecting parts should be ordered separately and in the appropriate quantity.

### Load diagram, cable tray MKSU 60 VA

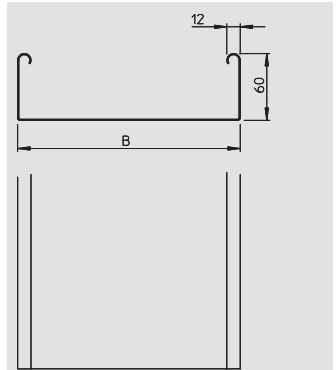
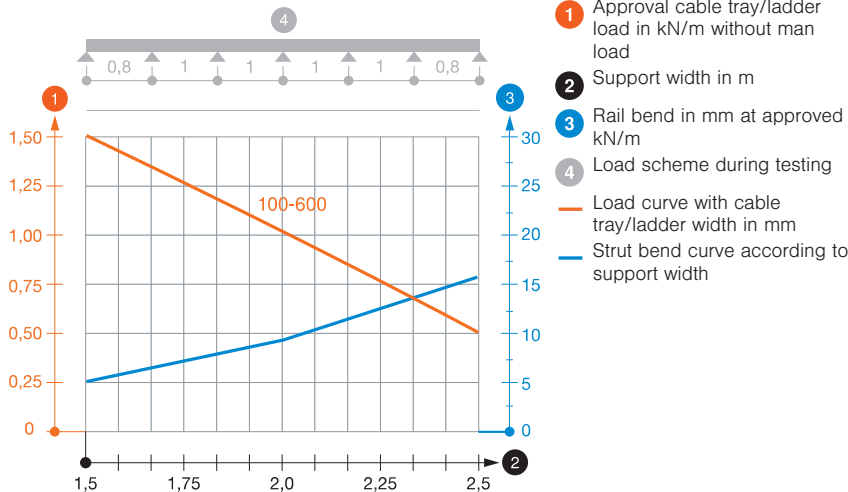

## Separating retainer

Type	Dimension H mm	Dimension L mm	Pack. m	Weight kg/100 m	Item No.
<b>TSG 60 VA4301</b>	60	3000	45	55,700	<b>6062 08 4</b>

V2A Stainless steel, grade 304 /m

Barrier strip for separation of cables of different voltages or functions.

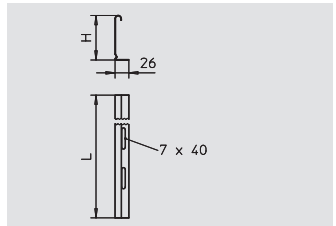

## Connector for separating retainer

Type	Pack. pcs	Weight kg/100 pcs.	Item No.
<b>TSGV VA4310</b>	10	1,000	<b>6067 97 0</b>

V2A Stainless steel, grade 301 /pc.

Barrier strip connector for screwless connection of the TSG barrier strip in all side heights.

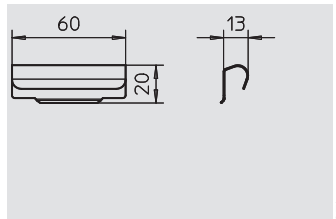

## Clamping piece for separating retainer fastening

Type	Pack. pcs	Weight kg/100 pcs.	Item No.
<b>KS KR VA4310</b>	30	0,580	<b>6062 28 0</b>

V2A Stainless steel, grade 301 price/100 pc.

Clamping piece for screwless fastening of barrier strips in the cable tray types RKSM, MKS and SKS.

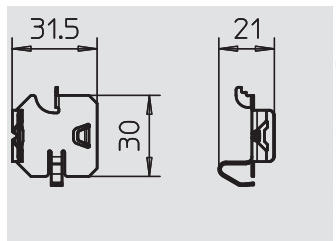

## Straight connector

Type	Side height mm	Pack. pcs	Weight kg/100 pcs.	Item No.
<b>RLVK 60 VA4301</b>	60	10	8,800	<b>6067 65 4</b>

V2A Stainless steel, grade 304 /pc.

Straight connector for connections of cable trays, fittings and barrier strips with a side height of 60 mm.

Including appropriate fastening material.

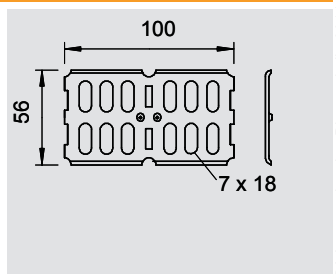

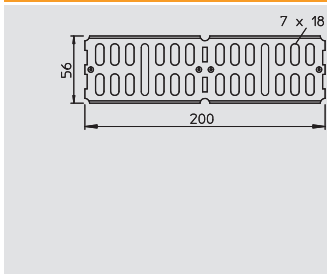

## Angle connector



Type	Side height mm	Pack.	Weight	Item No.
		pcs	kg/100 pcs.	
<b>RWVL 60 VA4301</b>	60	10	17,500	<b>6067 66 2</b>

V2A Stainless steel, grade 304 /pc.

Straight and angle connector for cable trays, fittings and barrier strips with a side height of 60 mm.

Including appropriate fastening material.

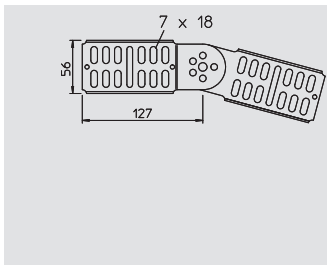

## Articulated connector



Type	Side height mm	Pack.	Weight	Item No.
		pcs	kg/100 pcs.	
<b>RGV 60 VA4301</b>	60	10	24,000	<b>7082 25 8</b>

V2A Stainless steel, grade 304 /pc.

Adjustable connector for cable trays and barrier strips with a side height of 60 mm.

Including appropriate fastening material.

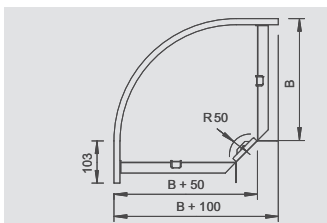

## 90° bend



Type	Width mm	Pack.	Weight	Item No.
		pcs	kg/100 pcs.	
<b>RB90 610 VA4301</b>	100	1	125,000	<b>7134 12 2</b>
<b>RB90 620 VA4301</b>	200	1	95,000	<b>7134 13 0</b>
<b>RB90 630 VA4301</b>	300	1	150,000	<b>7134 13 8</b>

V2A Stainless steel, grade 304 /pc.

90° bend, horizontal, for all cable tray types of 60 mm side height.

The fitting is shipped in an unmounted state.

Including appropriate fastening material.

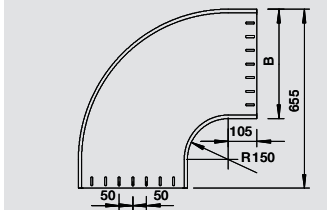

Type	Width mm	Pack.	Weight	Item No.
		pcs	kg/100 pcs.	
<b>RBU 90 640 VA4301</b>	400	1	500,000	<b>7134 23 1</b>
<b>RBU 90 650 VA4301</b>	500	1	650,000	<b>7134 25 8</b>
<b>RBU 90 660 VA4301</b>	600	1	825,000	<b>7134 26 6</b>

V2A Stainless steel, grade 304 /pc.

90° bend, horizontal and unperforated, for all cable tray types of 60 mm side height.

Fitting, unperforated, in round design. The interior radius of the fitting is 150 mm. Fastening materials should be ordered separately.

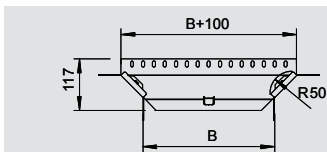

## Mounting/branch piece



Type	Width mm	Pack.	Weight	Item No.
		pcs	kg/100 pcs.	
<b>RAA 610 VA4301</b>	100	1	43,000	<b>7136 12 0</b>
<b>RAA 620 VA4301</b>	200	1	40,000	<b>7136 13 3</b>
<b>RAA 630 VA4301</b>	300	1	50,000	<b>7136 14 1</b>

V2A Stainless steel, grade 304 /pc.

Add-on tee for horizontal and vertical use. For all cable tray types of 60 mm side height.

The fitting is shipped in an unmounted state.

Including appropriate fastening material.

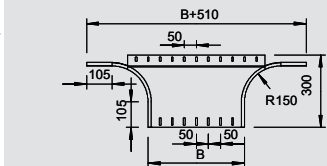

Type	Width mm	Pack.	Weight	Item No.
		pcs	kg/100 pcs.	
<b>RAAU 640 VA4301</b>	400	1	220,000	<b>7136 24 2</b>
<b>RAAU 650 VA4301</b>	500	1	255,000	<b>7136 25 0</b>
<b>RAAU 660 VA4301</b>	600	1	285,000	<b>7136 26 9</b>

V2A Stainless steel, grade 304 /pc.

Add-on tee, unperforated, for horizontal and vertical use. For all cable tray types of 60 mm side height.

Fitting in round design. The interior radius of the fitting is 150 mm. Fastening materials should be ordered separately.



# Cable tray systems

## Cover with sash lock



Type	Width mm	Plate thickness mm	Length mm	Weight kg/100 m	Item No.
<b>DRL 100 VA4301</b>	100	1	3000	105,000	<b>6052 87 8</b>
<b>DRL 200 VA4301</b>	200	1	3000	185,000	<b>6052 89 4</b>
<b>DRL 300 VA4301</b>	300	1	3000	264,000	<b>6052 90 8</b>
<b>DRL 400 VA4301</b>	400	1	3000	340,000	<b>6052 93 2</b>
<b>DRL 500 VA4301</b>	500	1,25	3000	625,000	<b>6052 95 9</b>
<b>DRL 600 VA4301</b>	600	1,25	3000	745,000	<b>6052 97 5</b>

V2A Stainless steel, grade 304

/m

Cover for cable trays and cable ladders with three pairs of turn-buckles.  
Ensure protective measures for construction if there are high wind speeds.  
Transverse bead from 500 mm width.

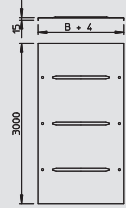

## Cover for mounting/branch piece



Type	Width mm	Plate thickness mm	Pack. pcs	Weight kg/100 pcs.	Item No.
<b>DFAA 100 VA4301</b>	100	1	1	52,500	<b>7136 90 0</b>
<b>DFAA 200 VA4301</b>	200	1	1	72,000	<b>7136 91 9</b>
<b>DFAA 300 VA4301</b>	300	1	1	92,000	<b>7136 92 7</b>

V2A Stainless steel, grade 304

/pc.

Cover for add-on tee with pre-mounted turn-buckles.  
The cover can be used with fittings of all side heights.



Type	Width mm	Plate thickness mm	Pack. pcs	Weight kg/100 pcs.	Item No.
<b>DFAA 400 VA4301</b>	400	1,25	1	111,500	<b>7136 93 5</b>
<b>DFAA 500 VA4301</b>	500	1,25	1	159,000	<b>7136 94 3</b>
<b>DFAA 600 VA4301</b>	600	1,25	1	183,500	<b>7136 97 8</b>

V2A Stainless steel, grade 304

/pc.

Cover for add-on tee with pre-mounted turn-buckles.  
The cover can be used with fittings of all side heights.

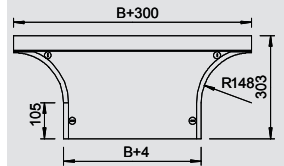
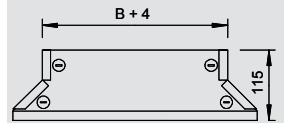

## Cover for 90° bend



Type	Width mm	Plate thickness mm	Pack. pcs	Weight kg/100 pcs.	Item No.
<b>DFB 90 100VA4301</b>	100	1	1	70,000	<b>7134 90 8</b>
<b>DFB 90 200VA4301</b>	200	1	1	130,000	<b>7134 91 6</b>
<b>DFB 90 300VA4301</b>	300	1	1	195,000	<b>7134 92 4</b>

V2A Stainless steel, grade 304

/pc.

Cover for 90° bend with pre-mounted turn-buckles.  
The cover can be used with fittings of all side heights.



Type	Width mm	Plate thickness mm	Pack. pcs	Weight kg/100 pcs.	Item No.
<b>DFB 90 400VA4301</b>	400	1,25	1	275,000	<b>7134 93 2</b>
<b>DFB 90 500VA4301</b>	500	1,25	1	470,000	<b>7134 94 0</b>
<b>DFB 90 600VA4301</b>	600	1,25	1	607,000	<b>7134 96 7</b>

V2A Stainless steel, grade 304

/pc.

Cover for 90° bend with pre-mounted turn-buckles.  
The cover can be used with fittings of all side heights.

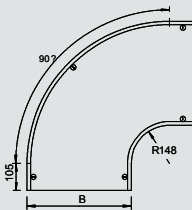
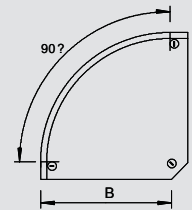

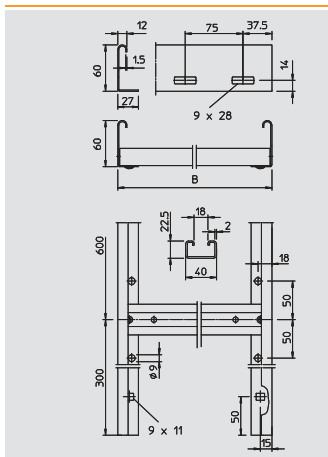

## Medium-duty vertical ladder

Type	Width	Length	Weight	Item No.
	mm	mm		
<b>SLL 620 CPS 4 FT</b>	200	6000	286,300	<b>6010 63 0</b>
<b>SLL 630 CPS 4 FT</b>	300	6000	314,000	<b>6010 63 2</b>
<b>SLL 640 CPS 4 FT</b>	400	6000	341,700	<b>6010 63 4</b>
<b>SLL 650 CPS 4 FT</b>	500	6000	369,200	<b>6010 63 6</b>
<b>SLL 660 CPS 4 FT</b>	600	6000	396,800	<b>6010 63 8</b>

**St** Steel **FT** Hot-dip galvanised /m

Vertical ladder with perforated side rail of side height 60 mm with riveted C profile rungs, open in an upwards direction.

Fastening takes place directly on the wall or using the wall brackets, type WB 30/75. The slot dimension of the rung is 18 mm and the appropriate U clamp is type 2056U.

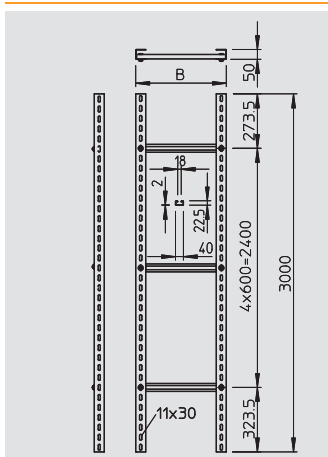

## Heavy-duty vertical ladder

Type	Width	Length	Weight	Item No.
	mm	mm		
<b>SLM 50 C40 2 FT</b>	200	3000	580,000	<b>6010 46 6</b>
<b>SLM 50 C40 3 FT</b>	300	3000	615,000	<b>6010 47 4</b>
<b>SLM 50 C40 4 FT</b>	400	3000	640,000	<b>6010 48 2</b>
<b>SLM 50 C40 5 FT</b>	500	3000	675,000	<b>6010 49 0</b>
<b>SLM 50 C40 6 FT</b>	600	3000	695,000	<b>6010 50 4</b>

**St** Steel **FT** Hot-dip galvanised /m

Vertical ladder of side height 50 mm with screwed-in C profile rungs, open in an upwards direction.

The ladder is shipped in an unmounted state.

The appropriate U clamp is type 2056U.



# Mounting systems



## Spacer clamp

Type	Dimension B mm	Pack. pcs	Weight kg/100 pcs.	Item No.
DBLG 20 050 FT	50	20	10,700	6015 64 8
DBLG 20 100 FT	100	20	14,300	6015 65 6
DBLG 20 150 FT	150	20	18,100	6015 66 0
DBLG 20 200 FT	200	20	21,700	6015 66 4
DBLG 20 300 FT	300	20	38,800	6015 67 2
DBLG 20 400 FT	400	20	48,600	6015 69 1
DBLG 20 500 FT	500	25	59,200	6015 69 5
DBLG 20 600 FT	600	25	69,100	6015 69 9

**St** Steel **FT** Hot-dip galvanised /pc.

Stand-off bracket for stand-off of mesh cable trays on the floor or on the wall.  
Screwless fastening of the mesh cable tray on the stand off bracket.

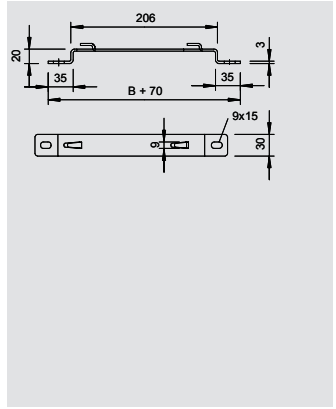

## US 3 suspended support

Type	Length mm	Material thickness mm	Tensile load kN	Pack. pcs	Weight kg/100 pcs.	Item No.
US 3 K 20 FT	200	2	5	1	50,500	6342 35 1
US 3 K 30 FT	300	2	5	1	64,400	6342 35 3
US 3 K 40 FT	400	2	5	4	78,300	6342 35 5
US 3 K 50 FT	500	2	5	1	92,300	6342 35 7
US 3 K 60 FT	600	2	5	1	106,200	6342 35 9
US 3 K 70 FT	700	2	5	1	120,200	6342 36 2
US 3 K 80 FT	800	2	5	1	134,100	6342 36 4
US 3 K 90 FT	900	2	5	1	147,800	6342 36 6
US 3 K 100 FT	1000	2	5	1	162,000	6342 36 8
US 3 K 110 FT	1100	2	5	1	175,900	6342 37 0
US 3 K 120 FT	1200	2	5	1	189,900	6342 37 2

**St** Steel **FT** Hot-dip galvanised /pc.

Suspended support (U profile) of dimensions 50 x 30 mm with welded head plate.

For fastening to horizontal concrete ceilings and steel girders. In the case of bracket mounting on both sides, or when mounting the bracket at the end of the support, use the spacer of type DSK 25.

### Load diagram, U support, type US 3 K

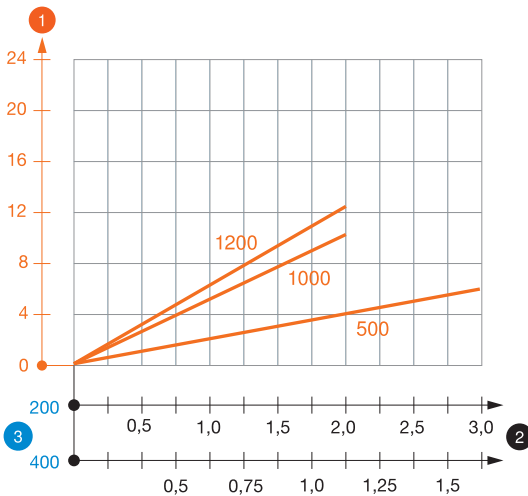

- 1 Bending of the end of the suspended support at approved bracket load
- 2 Approved bracket load in kN without man load
- 3 Bracket length in mm
- Load curves with support lengths in mm

### Characteristic anchor load values for US 3 K suspended support

Max. total load  $F = \text{cable weight} + \text{cable tray} + \text{bracket} + \text{suspended support}$ . The tabular values for double-sided loads take the available axis spacing  $a_i = 10 \text{ cm}$  into account. The load capacity values increase considerably when used in uncracked concrete. The specified values are based on concrete of resistance class C20/25. Comply with the installation conditions of the DIBt approval (anchors).

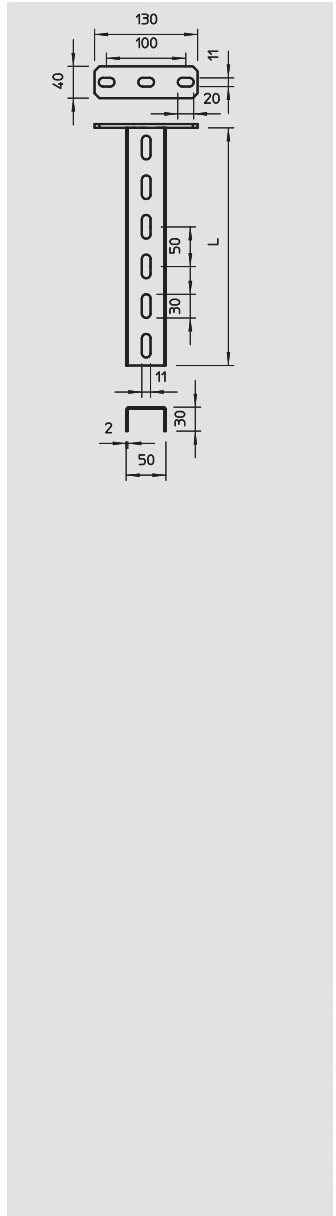



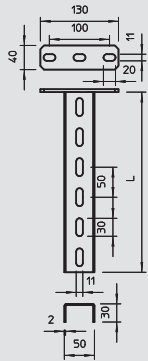

## US 3 suspended support

Type	Length mm	Material thickness mm	Tensile load kN	Pack. pcs	Weight kg/100 pcs.	Item No.
US 3 K 20VA4301	200	2	5	1	44,000	6342 40 1
US 3 K 30VA4301	300	2	5	1	58,000	6342 40 3
US 3 K 40VA4301	400	2	5	4	71,000	6342 40 5
US 3 K 50VA4301	500	2	5	1	84,000	6342 40 7
US 3 K 60VA4301	600	2	5	1	97,000	6342 40 9
US 3 K 70VA4301	700	2	5	1	110,000	6342 41 1
US 3 K 80VA4301	800	2	5	1	123,000	6342 41 3
US 3 K 90VA4301	900	2	5	1	137,000	6342 41 5
US 3 K 100VA4301	1000	2	5	1	150,000	6342 41 7

V2A Stainless steel, grade 304 Stained /pc.

Suspended support (U profile) of dimensions 50 x 30 mm with welded head plate.

For fastening to horizontal concrete ceilings and steel girders. In the case of bracket mounting on both sides, or when mounting the bracket at the end of the suspended support, use the spacer of type DSK 25.

### Load diagram, U support, type US 3 K

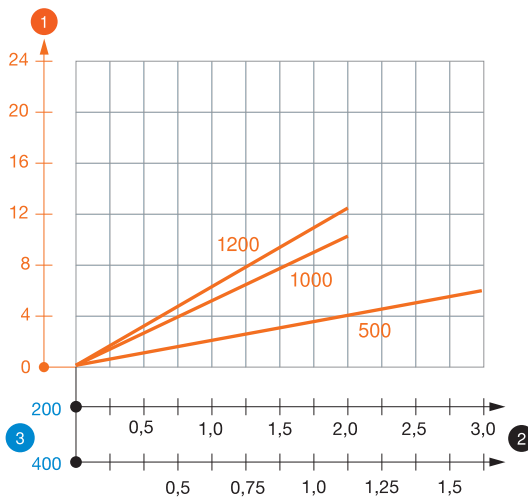

- 1 Bending of the end of the suspended support at approved bracket load
- 2 Approved bracket load in kN without man load
- 3 Bracket length in mm
- Load curves with support lengths in mm

### Characteristic anchor load values for US 3 K suspended support

Max. total load  $F = \text{cable weight} + \text{cable tray} + \text{bracket} + \text{suspended support}$ . The tabular values for double-sided loads take the available axis spacing  $a_i = 10 \text{ cm}$  into account. The load capacity values increase considerably when used in uncracked concrete. The specified values are based on concrete of resistance class C20/25. Comply with the installation conditions of the DIBt approval (anchors).

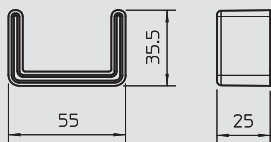

## Protective cap

Type	Colour	Pack. pcs	Weight kg/100 pcs.	Item No.
US 3 KS OR	Pastel orange	20	1,070	6338 45 8

PE Polyethylene /pc.

Protective cap to cover the ends of US 3 supports.



# Mounting systems



## US 5 suspended support

Type	Length mm	Material thickness mm	Tensile load kN	Pack. pcs	Weight kg/100 pcs.	Item No.
US 5 K 20 FT	200	2,5	10	1	85,000	6341 52 7
US 5 K 30 FT	300	2,5	10	2	110,000	6341 53 5
US 5 K 40 FT	400	2,5	10	1	136,000	6341 54 3
US 5 K 50 FT	500	2,5	10	1	161,000	6341 55 1
US 5 K 60 FT	600	2,5	10	1	185,000	6341 57 8
US 5 K 70 FT	700	2,5	10	1	210,000	6341 58 6
US 5 K 80 FT	800	2,5	10	1	236,000	6341 59 4
US 5 K 90 FT	900	2,5	10	1	261,000	6341 60 8
US 5 K 100 FT	1000	2,5	10	1	286,000	6341 61 6
US 5 K 110 FT	1100	2,5	10	1	311,000	6341 62 4
US 5 K 120 FT	1200	2,5	10	1	337,000	6341 63 2

**St** Steel **FT** Hot-dip galvanised /pc.

U support of dimensions 50 x 50 mm with welded head plate.

For fastening to horizontal concrete ceilings and steel girders. In the case of bracket mounting on both sides, or when mounting the bracket at the end of the support, use the spacer of type DSK 45.

### Load diagram, U support, type US 5 K

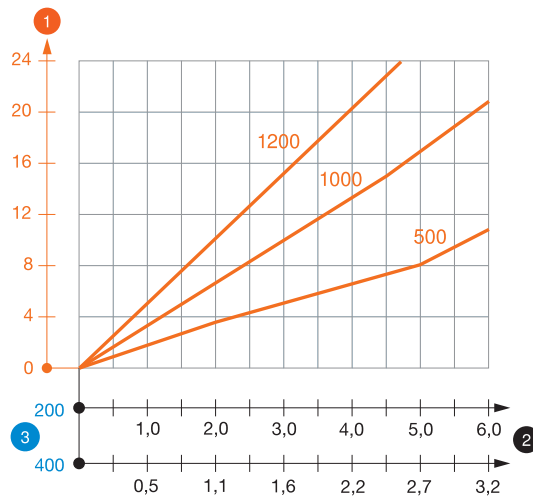

- 1 Bending of the end of the suspended support at approved bracket load
  - 2 Approved bracket load in kN without man load
  - 3 Bracket length in mm
- Load curves with support lengths in mm

### Characteristic anchor load values for US 5 K suspended support

Max. total load  $F = \text{cable weight} + \text{cable tray} + \text{bracket} + \text{suspended support}$ . The tabular values for double-sided loads take the available axis spacing  $a_i = 10 \text{ cm}$  into account. The load capacity values increase considerably when used in uncracked concrete. The specified values are based on concrete of resistance class C20/25. Comply with the installation conditions of the DIBt approval (anchors).

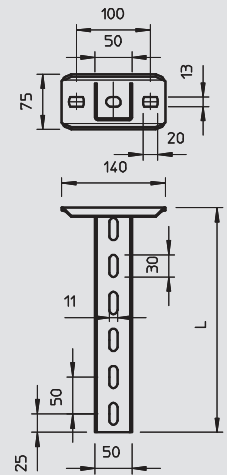

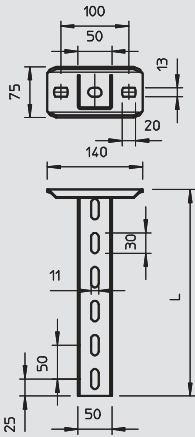

## US 5 suspended support

Type	Length mm	Material thickness mm	Pack. pcs	Weight kg/100 pcs.	Item No.
US 5 K 20 VA4301	200	2,5	1	100,000	6341 35 8
US 5 K 30 VA4301	300	2,5	2	125,000	6341 36 2
US 5 K 40 VA4301	400	2,5	1	150,000	6341 36 6
US 5 K 50 VA4301	500	2,5	1	175,000	6341 37 0
US 5 K 100VA4301	1000	2,5	1	300,000	6341 39 0
US 5 K 120VA4301	1200	2,5	1	360,000	6341 39 8

V2A Stainless steel, grade 304 Stained /pc.

U support with welded head plate.  
For fastening to horizontal concrete ceilings and steel girders.

In the case of bracket installation on both sides, or when installing the bracket at the end of the support, use the spacer of type DSK 45.

### Load diagram, U support, type US 5 K VA

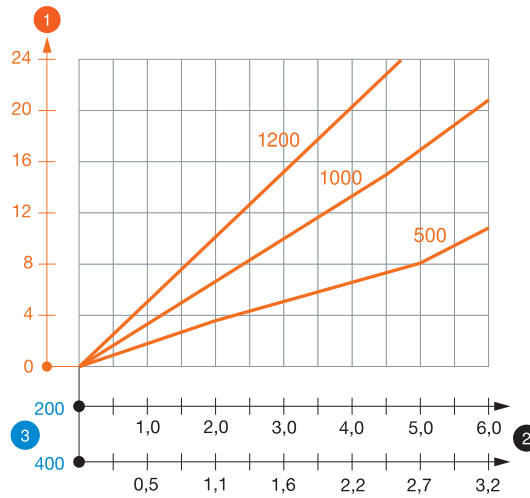

- 1 Bending of the end of the suspended support at approved bracket load
- 2 Approved bracket load in kN without man load
- 3 Bracket length in mm
- Load curves with support lengths in mm

### Characteristic anchor load values for US 5 K support

Max. total load  $F = \text{cable weight} + \text{cable tray} + \text{bracket} + \text{support}$ . The tabular values for double-sided loads take the available axis spacing  $a_i = 10 \text{ cm}$  into account. The load capacity values increase considerably when used in uncracked concrete. The values given are based on concrete of strength class C20/25. Observe the installation conditions of the DIBt approval (anchors).

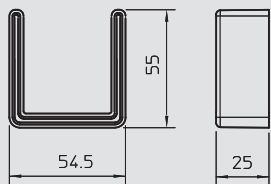

## Protective cap

Type	Colour	Pack. pcs	Weight kg/100 pcs.	Item No.
US 5 KS OR	Pastel orange	20	1,300	6338 46 2

PE Polyethylene /pc.

Protective cap for end covering of US 5 supports.



# Mounting systems



## Wall and support bracket AW 15

Type	Width	Dimension H	Dimension A	Hole-Ø	F in kN	Pack.	Weight	Item No.
	mm	mm	mm	mm	kN		kg/100 pcs.	
AW 15 11 FT	110	50	40	11	1,5	30	14,500	6420 65 6
AW 15 16 FT	160	55	40	11	1,5	30	21,000	6420 66 4
AW 15 21 FT	210	60	40	11	1,5	30	26,000	6420 68 0
AW 15 31 FT	310	65	40	11	1,5	30	32,500	6420 71 0
AW 15 41 FT	410	70	40	11	1,5	30	55,000	6420 74 5
AW 15 51 FT	510	75	40	11	1,5	20	72,000	6420 78 8
AW 15 56 FT	560	80	40	11	1,5	20	77,000	6420 79 6
AW 15 61 FT	610	80	40	11	1,5	20	85,000	6420 82 6
AW 15 11 VA4301	110	50	40	11	1,5	30	14,100	6421 00 8
AW 15 21 VA4301	210	60	40	11	1,5	30	25,600	6421 02 4
AW 15 31 VA4301	310	65	40	11	1,5	30	32,500	6421 03 2
AW 15 41 VA4301	410	70	40	11	1,5	30	55,000	6421 03 6
AW 15 51 VA4301	510	75	40	11	1,5	20	68,000	6421 04 0
AW 15 61 VA4301	610	80	40	11	1,5	20	85,000	6421 04 4

St Steel   
 V2A Stainless steel, grade 304   
 Stained   
 FT Hot-dip galvanised   
 /pc.

Light-duty wall and support bracket with welded head plate.

Fastening of the bracket to the U support of width 400 mm or greater using hexagonal bolt through both sides of the support. Please insert suitable spacers.

### Load diagram, bracket, type AW 15

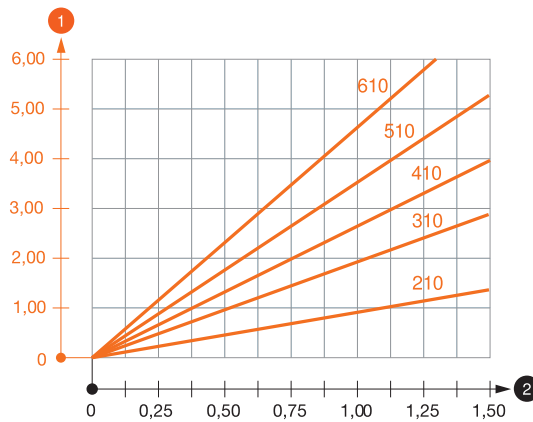

- 1 Bending of the bracket point at approved bracket load
- 2 Approved bracket load in kN without man load
- Load curve with bracket lengths in mm

### Characteristic anchor load values for wall and support bracket AW 15

Max. total load  $F = \text{cable weight} + \text{cable tray} + \text{bracket}$ . The load capacity values increase considerably when used in uncracked concrete. The specified values are based on concrete of resistance class C20/25. Comply with the installation conditions of the DIBt approval (anchors).

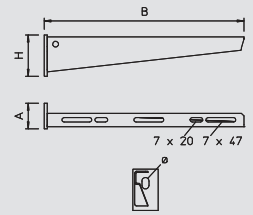

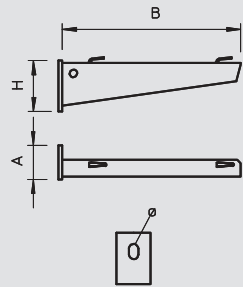

## Wall and support bracket AWG 15

Type	Width mm	Dimension H mm	Dimen- sion A mm	Hole- Ø mm	F in kN kN	Pack. pcs	Weight kg/100 pcs.	Item No.
<b>AW G 15 11 FT</b>	110	50	40	11	1,5	30	14,000	<b>6420 60 6</b>
<b>AW G 15 16 FT</b>	160	55	40	11	1,5	30	20,000	<b>6420 60 7</b>
<b>AW G 15 21 FT</b>	210	60	40	11	1,5	30	26,000	<b>6420 60 8</b>
<b>AW G 15 31 FT</b>	310	65	40	11	1,5	30	35,000	<b>6420 61 0</b>
<b>AW G 15 41 FT</b>	410	70	40	11	1,5	30	56,000	<b>6420 61 2</b>
<b>AW G 15 51 FT</b>	510	75	40	11	1,5	20	69,000	<b>6420 61 4</b>
<b>AW G 15 61 FT</b>	610	80	40	11	1,5	20	84,000	<b>6420 61 6</b>
<b>AWG 15 11VA4301</b>	110	50	40	11	1,5	30	13,000	<b>6420 62 5</b>
<b>AWG 15 21VA4301</b>	210	60	40	11	1,5	30	25,000	<b>6420 62 8</b>
<b>AWG 15 31VA4301</b>	310	65	40	11	1,5	30	33,000	<b>6420 63 1</b>
<b>AWG 15 41VA4301</b>	410	70	40	11	1,5	30	53,000	<b>6420 63 4</b>
<b>AWG 15 51VA4301</b>	510	75	40	11	1,5	20	65,000	<b>6420 63 7</b>
<b>AWG 15 61VA4301</b>	610	80	40	11	1,5	20	80,000	<b>6420 64 0</b>



**St** Steel    **V2A** Stainless steel, grade 304    Stained    **FT** Hot-dip galvanised    /pc.

Light-duty wall and support bracket with welded head plate for screwless mesh cable tray fastening.

Fastening of the bracket to the U support of width 400 mm or greater using hexagonal bolt through both sides of the support. Please insert suitable spacers.

### Load diagram, bracket type AW G 15

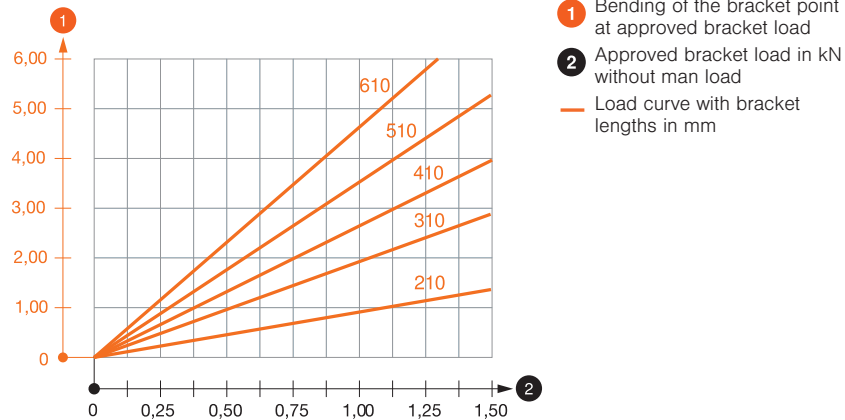

### Characteristic anchor load values for wall and support bracket AW G 15

Max. total load F = cable weight + cable tray + bracket. The load capacity values increase considerably when used in uncracked concrete. The specified values are based on concrete of resistance class C20/25. Comply with the installation conditions of the DIBt approval (anchors).



# Mounting systems



## Wall and support bracket AW 30

Type	Width mm	Dimension H mm	Dimension A mm	Hole- Ø mm	F in kN kN	Pack. pcs	Weight kg/100 pcs.	Item No.
AW 30 11 FT	110	60	50	11	3,0	30	24,000	6419 70 4
AW 30 16 FT	160	65	50	11	3,0	30	34,000	6419 71 2
AW 30 21 FT	210	70	50	13	3,0	25	42,000	6419 72 0
AW 30 31 FT	310	80	50	13	3,0	25	63,000	6419 74 7
AW 30 41 FT	410	80	50	13	3,0	20	93,000	6419 76 3
AW 30 51 FT	510	90	50	13	3,0	10	132,500	6419 79 8
AW 30 56 FT	560	100	50	13	3,0	10	185,000	6419 84 4
AW 30 61 FT	610	100	50	13	3,0	10	167,000	6419 82 8
AW 30 71 FT	710	100	50	13	3,0	1	214,000	6419 83 6

**St** Steel **FT** Hot-dip galvanised /pc.

Medium-duty wall and support bracket with welded head plate.

Fastening of the bracket to the U support of width 400 mm or greater using hexagonal bolt through both sides of the support. Please insert suitable spacers.

### Load diagram, bracket, type AW 30

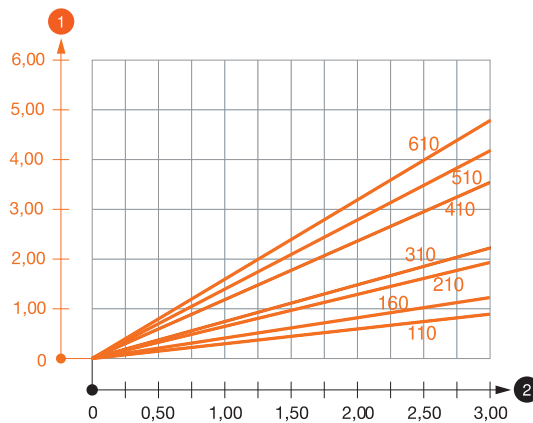

- 1 Bending of the bracket point at approved bracket load
- 2 Approved bracket load in kN without man load
- Load curve with bracket lengths in mm

### Characteristic anchor load values for wall and support bracket AW 30

Max. total load F = cable weight + cable tray + bracket. The load capacity values increase considerably when used in uncracked concrete. The specified values are based on concrete of resistance class C20/25. Comply with the installation conditions of the DIBt approval (anchors).

Type	Width mm	Dimension H mm	Dimension A mm	Hole- Ø mm	F in kN kN	Pack. pcs	Weight kg/100 pcs.	Item No.
AW 30 11 VA4301	110	60	50	11	3,0	30	21,200	6442 80 3
AW 30 21 VA4301	210	70	50	13	3,0	25	38,200	6442 83 8
AW 30 31 VA4301	310	80	50	13	3,0	25	61,000	6442 85 4
AW 30 41 VA4301	410	80	50	13	3,0	20	86,200	6442 87 0
AW 30 51 VA4301	510	90	50	13	3,0	10	126,000	6442 89 7
AW 30 61 VA4301	610	100	50	13	3,0	10	154,000	6442 91 9

**V2A** Stainless steel, grade 304 Stained /pc.

Medium-duty wall and support bracket with welded head plate.

Fastening of the bracket to the U support of width 400 mm or greater using hexagonal bolt through both sides of the support. Please insert suitable spacers.

### Load diagram, bracket AW 30 VA

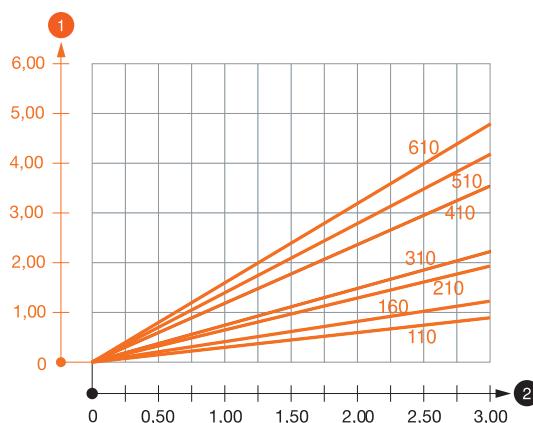

- 1 Bending of the bracket point at approved bracket load
- 2 Approved bracket load in kN without man load
- Load curve with bracket lengths in mm

### Characteristic anchor load values for wall and support bracket AW 30

Max. total load F = cable weight + cable tray + bracket. The load capacity values increase considerably when used in uncracked concrete. The values given are based on concrete of strength class C20/25. Observe the installation conditions of the DIBt approval (anchors).

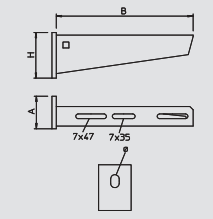
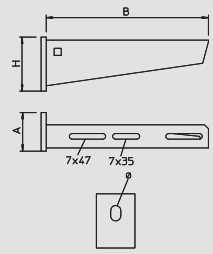

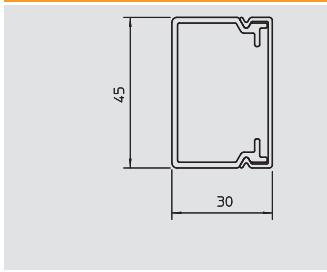

## Duct, type WDK-H 30045

Type	Colour	Length	Pack.	Weight	Item No.
		mm	m	kg/100 m	
<b>WDK-H30045</b>	Pure white	2000	32	28,000	<b>6175 00 8</b>

**PC/ABS** Polycarbonate/Acrylnitrile-butadiene-styrene /m  
 Trunking cover and base With base perforation made of halogen-free plastic.  
 During installation, ensure that only halogen-free accessories and fastening materials are used.

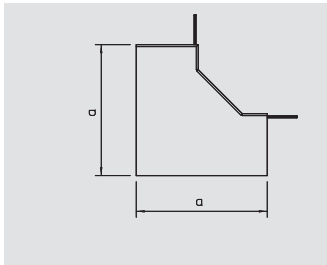

## Inner corner hood

Type	Colour	Dimension a	Pack.	Weight	Item No.
		mm	pcs	kg/100 pcs.	
<b>WDK-HI30045</b>	Pure white	60	1	2,200	<b>6175 05 1</b>

**PC/ABS** Polycarbonate/Acrylnitrile-butadiene-styrene /pc.  
 Internal corner cover for changing the direction of the halogen-free WDK-H trunking.

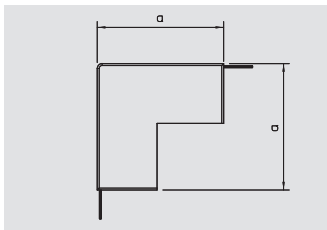

## External corner hood

Type	Colour	Dimension a	Pack.	Weight	Item No.
		mm	pcs	kg/100 pcs.	
<b>WDK-HA30045</b>	Pure white	60	1	2,700	<b>6175 10 3</b>

**PC/ABS** Polycarbonate/Acrylnitrile-butadiene-styrene /pc.  
 External corner cover for changing the direction of the WDK-H trunking.

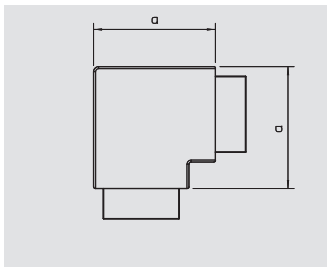

## Flat angle hood

Type	Colour	Dimension a	Pack.	Weight	Item No.
		mm	pcs	kg/100 pcs.	
<b>WDK-HF30045</b>	Pure white	60	1	1,900	<b>6175 20 4</b>

**PC/ABS** Polycarbonate/Acrylnitrile-butadiene-styrene /pc.  
 Flat angle cover for changing the direction of the halogen-free WDK-H trunking.

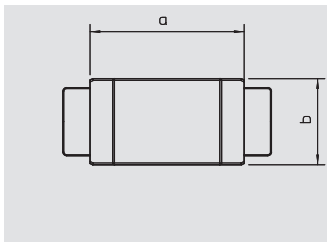

## T and intersection hood

Type	Colour	Dimension a	Pack.	Weight	Item No.
		mm	pcs	kg/100 pcs.	
<b>WDK-HT30045</b>	Pure white	130	1	3,300	<b>6175 25 5</b>

**PC/ABS** Polycarbonate/Acrylnitrile-butadiene-styrene /pc.  
 T and intersection cover for changing the direction of the halogen-free WDK-H trunking.

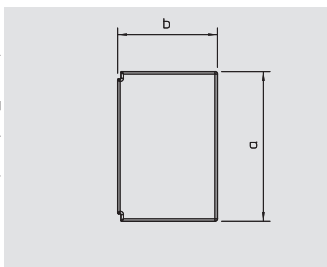

## End piece

Type	Colour	Dimension a	Dimension b	Pack.	Weight	Item No.
		mm	mm	pcs	kg/100 pcs.	
<b>WDK-HE30045</b>	Pure white	45	30	1	0,800	<b>6175 15 6</b>

**PC/ABS** Polycarbonate/Acrylnitrile-butadiene-styrene /pc.  
 End piece for closing the WDK-H trunking.



# Wall and ceiling duct



## Duct, type WDK-H 40060

Type	Colour	Length mm	Pack. m	Weight kg/100 m	Item No.
<b>WDK-H40060</b>	Pure white	2000	24	40,600	<b>6175 01 4</b>

**PC/ABS** Polycarbonate/Acrylnitrile-butadiene-styrene /m

Trunking cover and base With base perforation made of halogen-free plastic including cover fixing devices.

During installation, ensure that only halogen-free accessories and fastening materials are used.

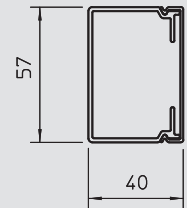

## Inner corner hood

Type	Colour	Dimension a mm	Pack. pcs	Weight kg/100 pcs.	Item No.
<b>WDK-HI40060</b>	Pure white	85	1	4,800	<b>6175 05 7</b>

**PC/ABS** Polycarbonate/Acrylnitrile-butadiene-styrene /pc.

Internal corner cover for changing the direction of the halogen-free WDK-H trunking.

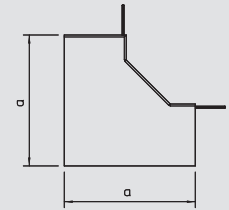

## External corner hood

Type	Colour	Dimension a mm	Pack. pcs	Weight kg/100 pcs.	Item No.
<b>WDK-HA40060</b>	Pure white	85	1	5,600	<b>6175 10 9</b>

**PC/ABS** Polycarbonate/Acrylnitrile-butadiene-styrene /pc.

External corner cover for changing the direction of the WDK-H trunking.

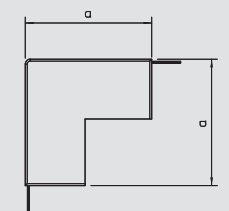

## Flat angle hood

Type	Colour	Dimension a mm	Pack. pcs	Weight kg/100 pcs.	Item No.
<b>WDK-HF40060</b>	Pure white	85	1	4,400	<b>6175 21 0</b>

**PC/ABS** Polycarbonate/Acrylnitrile-butadiene-styrene /pc.

Flat angle cover for changing the direction of the halogen-free WDK-H trunking.

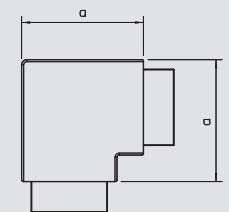

## T and intersection hood

Type	Colour	Dimension a mm	Dimension b mm	Pack. pcs	Weight kg/100 pcs.	Item No.
<b>WDK-HT40060</b>	Pure white	170	—	1	7,200	<b>6175 26 1</b>

**PC/ABS** Polycarbonate/Acrylnitrile-butadiene-styrene /pc.

T and intersection cover for changing the direction of the halogen-free WDK-H trunking.

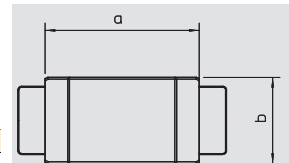

## End piece

Type	Colour	Dimension a mm	Dimension b mm	Pack. pcs	Weight kg/100 pcs.	Item No.
<b>WDK-HE40060</b>	Pure white	60	40	1	1,200	<b>6175 16 2</b>

**PC/ABS** Polycarbonate/Acrylnitrile-butadiene-styrene /pc.

End piece for closing the WDK-H trunking.

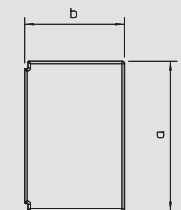

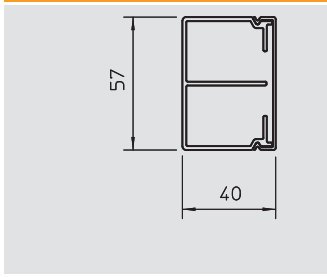

## Duct, type WDK-H 40061

Type	Colour	Length mm	Pack. m	Weight kg/100 m	Item No.
<b>WDK-H40061</b>	Pure white	2000	24	46,700	<b>6175 02 0</b>

**PC/ABS** Polycarbonate/Acrylnitrile-butadiene-styrene /m

Trunking cover and base With base perforation made of halogen-free plastic including cover fixing devices.

During installation, ensure that only halogen-free accessories and fastening materials are used.

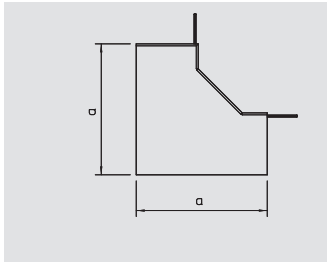

## Inner corner hood

Type	Colour	Dimension a mm	Pack. pcs	Weight kg/100 pcs.	Item No.
<b>WDK-HI40061</b>	Pure white	85	1	4,800	<b>6175 06 3</b>

**PC/ABS** Polycarbonate/Acrylnitrile-butadiene-styrene /pc.

Internal corner cover for changing the direction of the halogen-free WDK-H trunking.

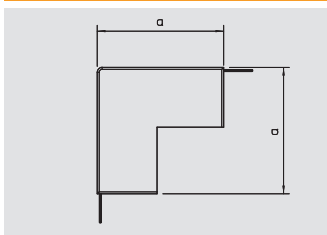

## External corner hood

Type	Colour	Dimension a mm	Pack. pcs	Weight kg/100 pcs.	Item No.
<b>WDK-HA40061</b>	Pure white	85	1	5,600	<b>6175 11 5</b>

**PC/ABS** Polycarbonate/Acrylnitrile-butadiene-styrene /pc.

External corner cover for changing the direction of the WDK-H trunking.

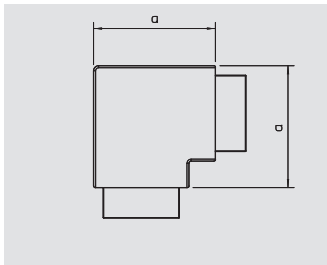

## Flat angle hood

Type	Colour	Dimension a mm	Pack. pcs	Weight kg/100 pcs.	Item No.
<b>WDK-HF40061</b>	Pure white	85	1	4,400	<b>6175 21 6</b>

**PC/ABS** Polycarbonate/Acrylnitrile-butadiene-styrene /pc.

Flat angle cover for changing the direction of the halogen-free WDK-H trunking.

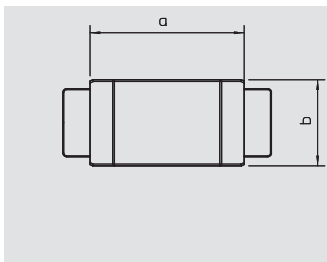

## T and intersection hood

Type	Colour	Dimension a mm	Pack. pcs	Weight kg/100 pcs.	Item No.
<b>WDK-HT40061</b>	Pure white	170	1	7,200	<b>6175 26 7</b>

**PC/ABS** Polycarbonate/Acrylnitrile-butadiene-styrene /pc.

T and intersection cover for changing the direction of the halogen-free WDK-H trunking.

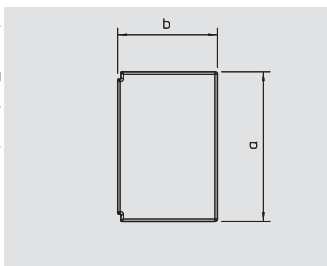

## End piece

Type	Colour	Dimension a mm	Dimension b mm	Pack. pcs	Weight kg/100 pcs.	Item No.
<b>WDK-HE40061</b>	Pure white	60	40	1	1,200	<b>6175 16 8</b>

**PC/ABS** Polycarbonate/Acrylnitrile-butadiene-styrene /pc.

End piece for closing the WDK-H trunking.



# Wall and ceiling duct



## Duct, type WDK-H 60090

Type	Colour	Length mm	Pack. m	Weight kg/100 m	Item No.
<b>WDK-H60090</b>	Pure white	2000	12	69,300	<b>6175 02 6</b>

**PC/ABS** Polycarbonate/Acrylnitrile-butadiene-styrene /m

Trunking cover and base With base perforation made of halogen-free plastic including cover fixing devices.

During installation, ensure that only halogen-free accessories and fastening materials are used.

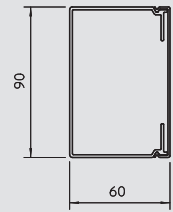

## Inner corner hood

Type	Colour	Dimension a mm	Pack. pcs	Weight kg/100 pcs.	Item No.
<b>WDK-HI60090</b>	Pure white	130	1	9,800	<b>6175 06 9</b>

**PC/ABS** Polycarbonate/Acrylnitrile-butadiene-styrene /pc.

Internal corner cover for changing the direction of the halogen-free WDK-H trunking.

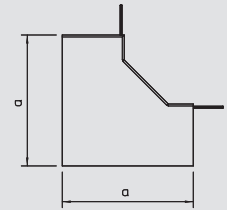

## External corner hood

Type	Colour	Dimension a mm	Pack. pcs	Weight kg/100 pcs.	Item No.
<b>WDK-HA60090</b>	Pure white	130	1	12,300	<b>6175 12 1</b>

**PC/ABS** Polycarbonate/Acrylnitrile-butadiene-styrene /pc.

External corner cover for changing the direction of the WDK-H trunking.

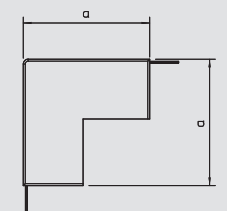

## Flat angle hood

Type	Colour	Dimension a mm	Pack. pcs	Weight kg/100 pcs.	Item No.
<b>WDK-HF60090</b>	Pure white	120	1	8,400	<b>6175 22 2</b>

**PC/ABS** Polycarbonate/Acrylnitrile-butadiene-styrene /pc.

Flat angle cover for changing the direction of the halogen-free WDK-H trunking.

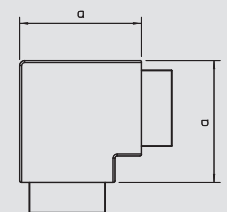

## T and intersection hood

Type	Colour	Dimension a mm	Pack. pcs	Weight kg/100 pcs.	Item No.
<b>WDK-HT60090</b>	Pure white	170	1	10,400	<b>6175 27 3</b>

**PC/ABS** Polycarbonate/Acrylnitrile-butadiene-styrene /pc.

Flat angle cover for changing the direction of the halogen-free WDK-H trunking.

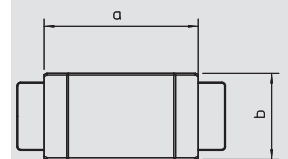

## End piece

Type	Colour	Dimension a mm	Dimension b mm	Pack. pcs	Weight kg/100 pcs.	Item No.
<b>WDK-HE60090</b>	Pure white	90	60	1	2,800	<b>6175 17 4</b>

**PC/ABS** Polycarbonate/Acrylnitrile-butadiene-styrene /pc.

End piece for closing the WDK-H trunking.

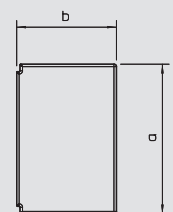



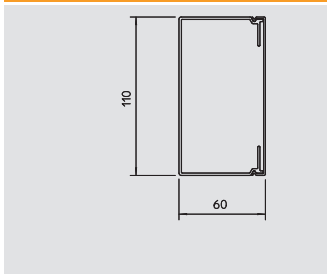

## Duct, type WDK-H 60110

Type	Colour	Length	Pack.	Weight	Item No.
		mm	m	kg/100 m	
<b>WDK-H60110</b>	Pure white	2000	24	89,600	<b>6175 03 2</b>

**PC/ABS** Polycarbonate/Acrylnitrile-butadiene-styrene /m  
 Trunking cover and base With base perforation made of halogen-free plastic including cover fixing devices.  
 During installation, ensure that only halogen-free accessories and fastening materials are used.

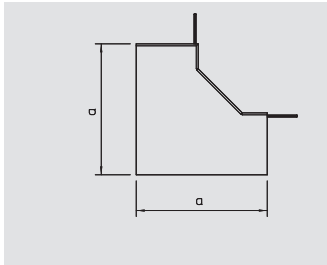

## Inner corner hood

Type	Colour	Dimension a	Pack.	Weight	Item No.
		mm	pcs	kg/100 pcs.	
<b>WDK-HI60110</b>	Pure white	130	1	12,500	<b>6175 07 5</b>

**PC/ABS** Polycarbonate/Acrylnitrile-butadiene-styrene /pc.  
 Internal corner cover for changing the direction of the halogen-free WDK-H trunking.

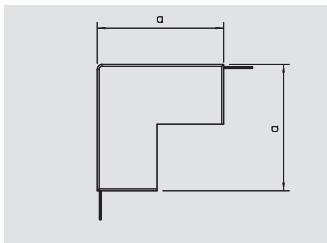

## External corner hood

Type	Colour	Dimension a	Pack.	Weight	Item No.
		mm	pcs	kg/100 pcs.	
<b>WDK-HA60110</b>	Pure white	130	1	14,000	<b>6175 12 7</b>

**PC/ABS** Polycarbonate/Acrylnitrile-butadiene-styrene /pc.  
 External corner cover for changing the direction of the WDK-H trunking.

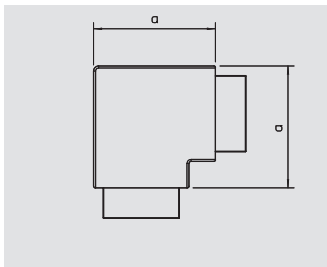

## Flat angle hood

Type	Colour	Dimension a	Pack.	Weight	Item No.
		mm	pcs	kg/100 pcs.	
<b>WDK-HF60110</b>	Pure white	140	1	11,200	<b>6175 22 8</b>

**PC/ABS** Polycarbonate/Acrylnitrile-butadiene-styrene /pc.  
 Flat angle cover for changing the direction of the halogen-free WDK-H trunking.

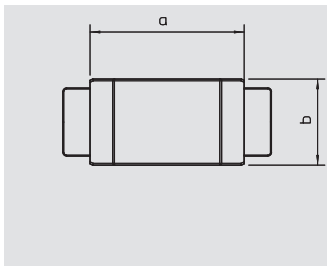

## T and intersection hood

Type	Colour	Dimension a	Pack.	Weight	Item No.
		mm	pcs	kg/100 pcs.	
<b>WDK-HT60110</b>	Pure white	190	1	13,800	<b>6175 27 9</b>

**PC/ABS** Polycarbonate/Acrylnitrile-butadiene-styrene /pc.  
 T and intersection cover for changing the direction of the halogen-free WDK-H trunking.

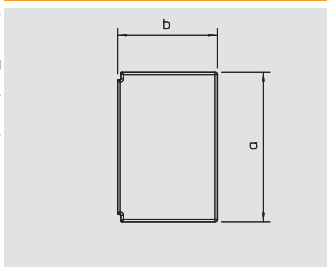

## End piece

Type	Colour	Dimension a	Dimension b	Pack.	Weight	Item No.
		mm	mm	pcs	kg/100 pcs.	
<b>WDK-HE60110</b>	Pure white	110	60	1	3,200	<b>6175 18 0</b>

**PC/ABS** Polycarbonate/Acrylnitrile-butadiene-styrene /pc.  
 End piece for closing the WDK-H trunking.



# Wall and ceiling duct



## Duct, type WDK-H 60150

Type	Colour	Length mm	Pack. m	Weight kg/100 m	Item No.
<b>WDK-H60150</b>	Pure white	2000	12	128,600	<b>6175 03 8</b>

**PC/ABS** Polycarbonate/Acrylnitrile-butadiene-styrene /pc.

Trunking cover and base With base perforation made of halogen-free plastic including cover fixing devices.

During installation, ensure that only halogen-free accessories and fastening materials are used.

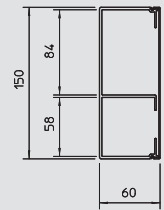

## Inner corner hood

Type	Colour	Dimension a mm	Pack. pcs	Weight kg/100 pcs.	Item No.
<b>WDK-HI60150</b>	Pure white	130	1	15,600	<b>6175 08 1</b>

**PC/ABS** Polycarbonate/Acrylnitrile-butadiene-styrene /pc.

Internal corner cover for changing the direction of the halogen-free WDK-H trunking.

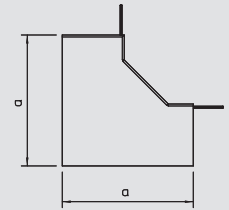

## External corner hood

Type	Colour	Dimension a mm	Pack. pcs	Weight kg/100 pcs.	Item No.
<b>WDK-HA60150</b>	Pure white	130	1	20,200	<b>6175 13 3</b>

**PC/ABS** Polycarbonate/Acrylnitrile-butadiene-styrene /pc.

External corner cover for changing the direction of the WDK-H trunking.

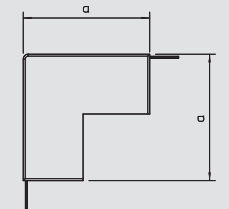

## Flat angle hood

Type	Colour	Dimension a mm	Pack. pcs	Weight kg/100 pcs.	Item No.
<b>WDK-HF60150</b>	Pure white	180	1	16,700	<b>6175 23 4</b>

**PC/ABS** Polycarbonate/Acrylnitrile-butadiene-styrene /pc.

Flat angle cover for changing the direction of the halogen-free WDK-H trunking.

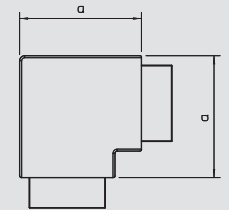

## T and intersection hood

Type	Colour	Dimension a mm	Pack. pcs	Weight kg/100 pcs.	Item No.
<b>WDK-HT60150</b>	Pure white	250	1	21,700	<b>6175 28 5</b>

**PC/ABS** Polycarbonate/Acrylnitrile-butadiene-styrene /pc.

T and intersection cover for changing the direction of the halogen-free WDK-H trunking.

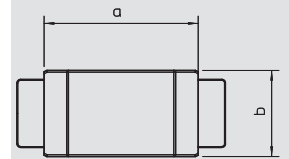

## End piece

Type	Colour	Dimension a mm	Dimension b mm	Pack. pcs	Weight kg/100 pcs.	Item No.
<b>WDK-HE60150</b>	Pure white	150	60	1	4,000	<b>6175 18 6</b>

**PC/ABS** Polycarbonate/Acrylnitrile-butadiene-styrene /pc.

End piece for closing the WDK-H trunking.

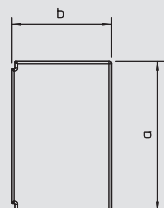

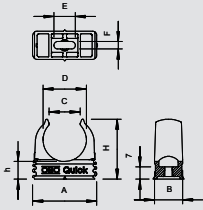

## Quick Clip



Type	Nominal size	Colour	Shipping box pcs	Pack.	Weight	Item No.
				pcs	kg/100 pcs.	
2955 M16	M16	Light grey	1200	100	0,252	2149 00 4
2955 M20	M20	Light grey	1200	100	0,325	2149 01 0
2955 M25	M25	Light grey	1200	100	0,433	2149 01 6
2955 M32	M32	Light grey	600	50	0,630	2149 02 2
2955 M40	M40	Light grey	600	50	0,835	2149 02 8
2955 M50	M50	Light grey	300	25	1,454	2149 03 4
2955 M63	M63	Light grey	240	20	2,203	2149 04 0
2955 M16 SW	M16	Jet black	1200	100	0,252	2149 55 9
2955 M20 SW	M20	Jet black	1200	100	0,325	2149 56 3
2955 M25 SW	M25	Jet black	1200	100	0,433	2149 56 7
2955 M32 SW	M32	Jet black	600	50	0,630	2149 57 1
2955 M40 SW	M40	Jet black	600	50	0,835	2149 57 5
2955 M50 SW	M50	Jet black	300	25	1,454	2149 57 9
2955 M63 SW	M63	Jet black	240	20	2,203	2149 58 3



PP Polypropylene

price/100 pc.

OBO Quick clip, type 2955/...: for all metric steel armoured pipes, as well as light-duty and heavy-duty metric insulation pipes. Suitable for mounting the OBO Quick pipe.

Pipe centring aids allow optimum attachment of the pipe and automatically turn the clip into the correct position.

Universal fastening option; can be arranged with the OBO Multi-quick and starQuick clip.

Slot for side alignment during mounting with wood screw or knock-in anchor.

Sizes M16–M32 can be screwed onto M6 thread.

Recommended fastening spacing 50–60 cm.

For max. extraction values F at a room temperature of 20 °C, see the table.

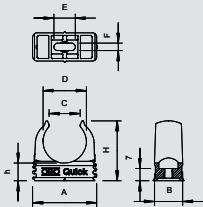

## Quick Clip, flame-resistant

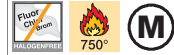

Type	Nominal size	Colour	Shipping box pcs	Pack.	Weight	Item No.
				pcs	kg/100 pcs.	
2955 F M16 STGR	M16	Stone grey	1200	100	0,252	2149 30 3
2955 F M20 STGR	M20	Stone grey	1200	100	0,325	2149 30 9
2955 F M25 STGR	M25	Stone grey	1200	100	0,433	2149 31 5
2955 F M32 STGR	M32	Stone grey	600	50	0,630	2149 32 1
2955 F M40 STGR	M40	Stone grey	600	50	0,835	2149 32 7
2955 F M50 STGR	M50	Stone grey	300	25	1,454	2149 33 3
2955 F M63 STGR	M63	Stone grey	240	20	2,203	2149 33 9
2955 F M16 RW	M16	Pure white	1200	100	0,252	2149 35 1
2955 F M20 RW	M20	Pure white	1200	100	0,325	2149 35 7
2955 F M25 RW	M25	Pure white	1200	100	0,433	2149 36 3
2955 F M32 RW	M32	Pure white	600	50	0,630	2149 36 9
2955 F M40 RW	M40	Pure white	600	50	0,835	2149 37 5
2955 F M50 RW	M50	Pure white	300	25	1,454	2149 38 1



PP Polypropylene

price/100 pc.

OBO Quick clip, type 2955F/...: flame-resistant version for all metric steel armoured pipes, as well as light-duty and heavy-duty metric insulation pipes. Suitable for mounting the OBO Quick pipe.

Pipe centring aids allow optimum attachment of the pipe and automatically turn the clip into the correct position.

Universal fastening option; can be arranged with the OBO Multi-quick and starQuick clip.

Slot for side alignment during mounting with wood screw or knock-in anchor.

Size M16–M32 can be screwed onto M6 thread.

Recommended fastening spacing 50–60 cm.

For max. extraction values F at a room temperature of 20 °C, see the table.

# Cable and pipe fastening systems, plastic



## starQuick clip

Type	Size	Clamping range D mm	Breaking load kN	Colour	Shipping box pcs	Pack. pcs	Weight kg/100 pcs.	Item No.
SQ-10 LGR	10	9,5-12	0,5	Light grey	1200	100	0,560	2146 05 3
SQ-12 LGR	12-14	11,5-15	0,55	Light grey	1200	100	0,540	2146 06 1
SQ-15 LGR	15-16	14-16,5	0,6	Light grey	1200	100	0,580	2146 09 6
SQ-17 LGR	17-19	16-20	0,7	Light grey	800	100	0,640	2146 11 8
SQ-20 LGR	20-23	19,5-23,5	0,8	Light grey	600	50	0,670	2146 13 4
SQ-25 LGR	25-28	24-28	0,85	Light grey	600	50	0,970	2146 20 7
SQ-28 LGR	28-32	27,5-32	0,9	Light grey	400	50	1,070	2146 21 5
SQ-32 LGR	32-35	31,2-35,8	1	Light grey	400	50	1,230	2146 25 8
SQ-36 LGR	35-40	35-40,1	1,1	Light grey	300	25	1,510	2146 29 0
SQ-40 LGR	40-44	39,3-44,5	1,2	Light grey	200	25	1,710	2146 32 0
SQ-47 LGR	45-50	44-50	1,2	Light grey	200	25	1,980	2146 36 3
SQ-51 LGR	50-54	48-55	1,4	Light grey	180	15	2,250	2146 44 4
SQ-59 LGR	59-65	58,5-65	1,5	Light grey	180	15	3,300	2146 48 7

PA Polyamide price/100 pc.

Can be arranged next to each other to size SQ-28.

Break load: with bolt DIN 96; diameter 4.5 mm, minimum break load at 20°.

starQuick clip Type SQ... a comprehensive programme of quality clips ideal for the use in outside areas such as parking garages, under bridges and on the exterior of steel structures. Climate conditions have no chance: the starQuick clips are made from UV weather-resistant polyamide.

The starQuick clips are available in 13 different sizes with a clamping range of 10–65 mm, allowing a problem-free installation on different pipe systems. starQuick is suitable for plastic and metal pipes, as well as electrical and sanitary installations. The clips can be installed on the wall and ceiling. Mounting is amazingly fast and uncomplicated, without the use of tools. Mounting of multiple pipes is also really easy:

- By arranging the single clips.
- By using the double bracket, allowing a firm hold and spacing by heavy loads.
- A rail system allows for an open spacing and numbering of the clips.

starQuick is reliable and can support heavy loads. A patented safety system guarantees that the pipes stay where they are. The pipe is secure in the all around closed clip.

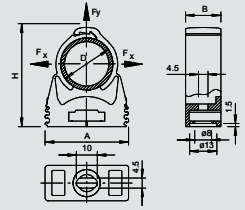

## starQuick nut

Type	Thread	Dimension L mm	Dimension h mm	Dimension t mm	Colour	Shipping box pcs	Pack. pcs	Weight kg/100 pcs.	Item No.
SQ M6	M6	15	5	4	Light grey	12000	100	0,070	2146 50 9
SQ M8	M8	15	5	4	Light grey	12000	100	0,070	2146 51 1

PC Polycarbonate price/100 pc.

The starQuick nut was developed especially for the starQuick clip. Simply push into the intended opening of the starQuick. The starQuick nut is captive in the clip. Suitable for M6/M8 threads.

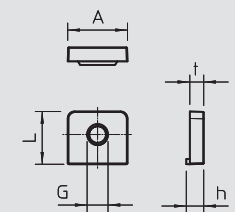

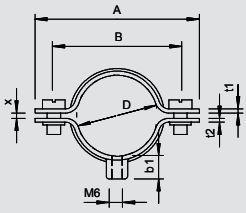

## Cable and pipe spacer clip

Type	Clamping range D mm	Size	Bolt	Shipping box pcs	Pack. pcs	Weight kg/100 pcs.	Item No.
732 6 GTP	5-6	-	M5 x 10	1200	100	1,160	1360 05 1
732 8 GTP	7-8	-	M5 x 10	1200	100	1,310	1360 08 6
732 10 GTP	9-10	-	M5 x 12	1000	100	1,360	1360 10 8
732 12 GTP	10,5-12	M12	M5 x 12	1000	100	1,460	1360 12 4
732 14 GTP	12,5-14	PG7	M5 x 12	1000	100	1,480	1360 14 0
732 15 GTP	13,5-15	PG9	M5 x 12	1000	100	1,530	1360 15 9
732 16 GTP	14,5-16	M16	M5 x 12	1000	100	1,590	1360 16 7
732 18 GTP	16,5-18	PG11	M5 x 12	1000	100	1,620	1360 18 3
732 20 GTP	18,5-20	M20	M5 x 12	600	50	1,730	1360 20 5
732 22 GTP	20-22	PG13,5	M5 x 12	500	50	1,780	1360 22 1
732 24 GTP	22-24	PG16	M5 x 12	500	50	1,840	1360 24 8
732 26 GTP	24-26	M25	M5 x 12	500	50	1,920	1360 26 4
732 28 GTP	26-28	PG21	M5 x 12	500	50	2,840	1360 28 0
732 30 GTP	28-30	PG21	M5 x 12	400	50	3,040	1360 30 2
732 33 GTP	31-33	M32	M5 x 12	250	25	3,120	1360 33 7
732 35 GTP	33-35	-	M5 x 12	250	25	3,280	1360 35 3
732 38 GTP	36-38	PG29	M5 x 12	250	25	3,490	1360 38 8
732 40 GTP	38-40	M40	M5 x 12	250	25	3,600	1360 39 6
732 42 GTP	40-42	M40	M5 x 12	250	25	3,840	1360 42 6
732 45 GTP	43-45	-	M5 x 12	250	25	3,990	1360 45 0
732 48 GTP	46-48	PG36	M5 x 12	250	25	4,040	1360 48 5
732 50 GTP	48-50	M50	M5 x 14	200	25	4,160	1360 50 7
732 60 GTP	58-60	PG48	M5 x 14	200	25	4,960	1360 60 4
732 63 GTP	61-63	M63	M5 x 14	200	25	5,000	1360 63 9

**St** Steel      **GTP** Electrogalvanised, transparently passivated      price/100 pc.  
With M6 thread.

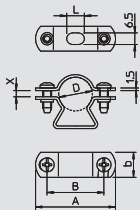

## Cable and pipe spacer clip

Type	Clamping range D mm	Hole size mm	Material thickness mm	Size	Bolt	Shipping box pcs	Pack. pcs	Weight kg/100 pcs.	Item No.
733 16 VA	14-16	6,5 x 10	1,5	M16	M5 x 12	500	50	2,430	1362 01 1
733 19 VA	17-19	6,5 x 10	1,5	Pg11	M5 x 16	500	50	2,800	1362 03 8
733 21 VA	19-21	6,5 x 10	1,5	M20	M5 x 16	500	50	2,740	1362 04 6
733 23 VA	21-23	6,5 x 10	1,5	Pg16	M5 x 16	500	50	2,800	1362 05 4
733 29 VA	24-29	6,5 x 10	1,5	M25	M5 x 16	450	50	3,475	1362 06 2
733 38 VA	30-38	6,5 x 10	1,5	M32	M5 x 18	250	25	4,500	1362 07 0
733 48 VA	39-48	6,5 x 10	1,5	M40	M5 x 18	300	25	5,200	1362 08 9
733 54 VA	48-54	6,5 x 14	1,5	M50	M5 x 18	300	25	5,800	1362 09 7
733 61 VA	53-61	6,5 x 14	1,5	Pg48	M5 x 18	240	20	6,800	1362 10 0
733 63 VA	63	8 x 18	2	M63	M5 x 18	160	20	6,940	1362 12 7

**V2A** Stainless steel, grade 304      price/100 pc.

Bolt material: VA  
\* Size M16 not suitable for nail device.  
\* Sizes M16 to PG16 not suitable for bolt-firing tool.

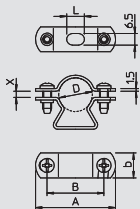

Type	Clamping range D mm	Hole size mm	Material thickness mm	Size	Bolt	Shipping box pcs	Pack. pcs	Weight kg/100 pcs.	Item No.
733 13 FT	11-13	6,5 x 10	1,5	M 12	M5 x 12	600	50	2,310	1361 09 1
733 16 FT	14-16	6,5 x 10	1,5	M 16	M5 x 14	500	50	2,430	1361 09 4
733 19 FT	17-19	6,5 x 10	1,5	Pg 11	M5 x 14	500	50	2,500	1361 09 7
733 21 FT	19-21	6,5 x 10	1,5	M 20	M5 x 14	500	50	2,730	1361 10 0
733 23 FT	21-23	6,5 x 10	1,5	Pg 16	M5 x 14	500	50	2,870	1361 10 3
733 29 FT	24-29	6,5 x 10	1,5	M 25	M5 x 18	450	50	3,480	1361 10 6
733 38 FT	30-38	6,5 x 10	1,5	M 32	M5 x 18	250	25	4,040	1361 10 9
733 48 FT	39-48	6,5 x 10	1,5	M 40	M5 x 18	300	25	4,810	1361 11 2
733 54 FT	48-54	6,5 x 10	1,5	M 50	M5 x 18	300	25	5,400	1361 11 7
733 61 FT	53-61	6,5 x 10	1,5	Pg48	M5 x 18	240	20	6,100	1361 11 5
733 63 FT	63	6,5 x 10	2	M 63	M5 x 18	160	20	7,250	1361 11 8

**St** Steel      **FT** Hot-dip galvanised      price/100 pc.

Bolt material: steel.  
\* Size M16 not suitable for nail device.  
\* Sizes M16 to PG16 not suitable for bolt-firing tool and nail device.





# Cable and pipe fastening systems, metal



## Fastening clip, medium-duty 5–18 mm

Type	For Ø mm	Shipping box pcs	Pack. pcs	Weight kg/100 pcs.	Item No.
1015 6 G	6	2400	100	0,385	1009 03 6
1015 7 G	7	2000	100	0,418	1009 04 4
1015 8 G	8	2000	100	0,428	1009 05 2
1015 9 G	9	2000	100	0,468	1009 06 0
1015 10 G	10	2000	100	0,560	1009 07 9
1015 11 G	11	1800	100	0,632	1009 08 7
1015 12 G	12	1000	100	0,672	1009 10 9
1015 13 G	13	1800	100	0,683	1009 11 7
1015 14 G	14	1200	100	0,710	1009 16 8
1015 15 G	15	1200	100	0,744	1009 18 4
1015 16 G	16	1200	100	0,753	1009 19 2
1015 17 G	17	1200	100	0,764	1009 20 6
1015 18 G	18	1200	100	0,835	1009 21 4

**St** Steel      **G** Electrogalvanised      price/100 pc.

Single-lobe fastening clip for cables and pipes.  
Beading from size 20.

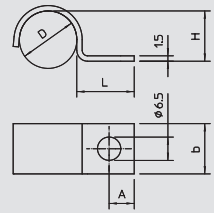

## Fastening clip, heavy-duty

Type	For Ø mm	Hole size mm	Material thickness mm	Shipping box pcs	Pack. pcs	Weight kg/100 pcs.	Item No.
823 18.3 FT	18,6	6,5 x 10	2	500	50	2,446	1015 11 7
823 20 FT	20	6,5 x 10	2	500	50	2,662	1015 13 3
823 22.5 FT	22,5	6,5 x 10	2	400	50	2,988	1015 16 8
823 25 FT	25	6,5 x 10	3	250	25	6,770	1015 49 4
823 28.3 FT	28,3	6,5 x 10	3	250	25	5,208	1015 21 4
823 32 FT	32	6,5 x 10	3	100	100	7,469	1015 49 6
823 37 FT	37	6,5 x 10	3	100	100	8,700	1015 30 3
823 40 FT	40	6,5 x 10	3	100	100	8,460	1015 49 8
823 47 FT	47	6,5 x 10	3	100	100	10,120	1015 36 2
823 54 FT	54	6,5 x 10	3	100	100	10,760	1015 42 7
823 59.3 FT	59,3	6,5 x 10	3	100	100	11,800	1015 48 6
823 50 FT	50	6,5 x 10	3	100	100	9,808	1015 50 0
823 63 FT	63	6,5 x 10	3	100	100	11,553	1015 50 8

**St** Steel      **FT** Hot-dip galvanised      price/100 pc.

Two lobe fastening clips for cables and pipes.

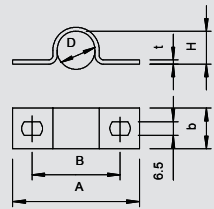

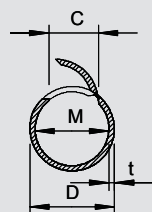

**Quick Pipe**



Type	Size	Colour	Length mm	Pack.	Weight	Item No.
				m	kg/100 m	
2953 M16 LGR	M16	Light grey	2000	50	7,000	2153 90 4
2953 M20 LGR	M20	Light grey	2000	40	11,500	2153 91 2
2953 M25 LGR	M25	Light grey	2000	30	16,000	2153 92 0
2953 M32 LGR	M32	Light grey	2000	20	21,500	2153 93 9

**PVC** Polyvinylchloride price/100 m

Smallest shipped quantity is shipping box.

The Quick pipe combines the advantages of a cable duct and an installation pipe into an intelligent system. It allows tidy and safe surface-mounted installation of all kinds of cables – even in a pipe. Quick pipe is available in four metric sizes: M16, M20, M25 and M32. The stock length is 2 m. The system is VDE-tested and achieves a protection rating of IP44. The fittings are a component part of the system.

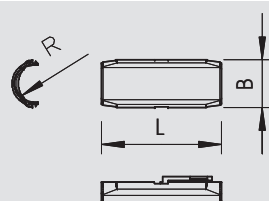

**Connection sleeve**



Type	Size	Colour	Shipping box pcs	Pack.	Weight	Item No.
				pcs	kg/100 pcs.	
2953 M M16 LGR	M16	Light grey	150	10	0,910	2153 82 9
2953 M M20 LGR	M20	Light grey	100	10	1,020	2153 83 1
2953 M M25 LGR	M25	Light grey	120	10	1,130	2153 83 3
2953 M M32 LGR	M32	Light grey	100	10	1,250	2153 83 5

**PVC** Polyvinylchloride /pc.

Connection sleeves are tested to VDE 0604 (system consists of: Quick pipe + fittings + 2955 F/...).

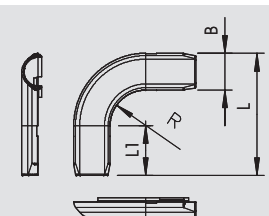

**90° bend**



Type	Size	Colour	Shipping box pcs	Pack.	Weight	Item No.
				pcs	kg/100 pcs.	
2953 B M16 LGR	M16	Light grey	60	5	1,810	2153 86 4
2953 B M20 LGR	M20	Light grey	50	5	1,900	2153 86 6
2953 B M25 LGR	M25	Light grey	50	5	2,020	2153 86 8
2953 B M32 LGR	M32	Light grey	60	5	2,140	2153 87 0

**PVC** Polyvinylchloride /pc.

90° bends are tested to VDE 0604 (system consists of: Quick pipe + fittings + 2955 F/...).

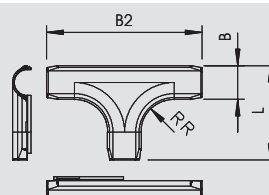

**T piece**



Type	Size	Colour	Shipping box pcs	Pack.	Weight	Item No.
				pcs	kg/100 pcs.	
2953 T M16 LGR	M16	Light grey	60	5	2,210	2153 87 2
2953 T M20 LGR	M20	Light grey	50	5	2,320	2153 87 4
2953 T M25 LGR	M25	Light grey	50	5	2,440	2153 87 6
2953 T M32 LGR	M32	Light grey	50	5	2,560	2153 87 8

**PVC** Polyvinylchloride /pc.

T pieces are tested to VDE 0604 (system consists of: Quick pipe + fittings + 2955 F/...).

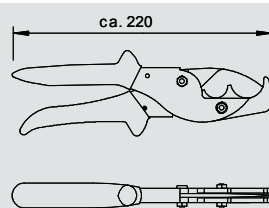

**Quick duct shears**

Type	Cutting area mm	Pack.	Weight	Item No.
		pcs	kg/100 pcs.	
SQ 1632	16 -32,0	1	40,000	2153 57 2

/pc.

For exact, burr-free cutting of the Quick ducts and Quick pipe of Ø 16–32 mm.

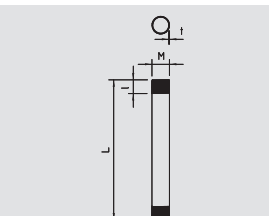

**Metal pipe, with threaded ends**

Type	Dimen- sion M	Dimen- sion L	Dimen- sion I	Dimen- sion t	Pack.	Weight	Item No.
					m	kg/100 m	
SM16 VA	M16x1,5	3000	13	1,5	51	53,600	2047 65 7
SM20 VA	M20x1,5	3000	14	1,5	51	68,400	2047 65 8
SM25 VA	M25x1,5	3000	19	1,5	30	86,900	2047 66 0
SM32 VA	M32x1,5	3000	19	1,5	21	112,800	2047 66 1
SM40 VA	M40x1,5	3000	19	1,5	15	142,400	2047 66 2

**V2A** Stainless steel, grade 304 price/100 m

Stainless steel electrical installation pipe with threaded ends to EN 61386 (Code: 5557) for mechanical protection of cables.

One connection sleeve is already screwed onto each pipe.



# Pipe systems



## Metal pipe, without thread

Type	Dimen- sion D	Dimen- sion L	Dimen- sion t	Pack.	Weight	Item No.
	mm	mm	mm		m	
<b>S16 VA</b>	16	3000	1	51	37,000	<b>2047 65 0</b>
<b>S20 VA</b>	20	3000	1	51	46,900	<b>2047 65 1</b>
<b>S25 VA</b>	25	3000	1	30	59,200	<b>2047 65 2</b>
<b>S32 VA</b>	32	3000	1,25	21	94,800	<b>2047 65 3</b>
<b>S40 VA</b>	40	3000	1,25	15	119,500	<b>2047 65 4</b>

V2A Stainless steel, grade 304

price/100 m

Stainless steel electrical installation pipe without threaded ends to EN 61386 (Code: 5557) for mechanical protection of cables.



## Metal pipe bend, with threaded ends

Type	Dimen- sion M	Dimen- sion L	Dimen- sion I	Dimen- sion A	Dimen- sion R	Dimen- sion t	Pack.	Weight	Item No.
								pcs	
<b>SBM16 VA</b>	M16x1,5	178	13	65	97	1,5	10	8,000	<b>2047 69 0</b>
<b>SBM20 VA</b>	M20x1,5	183	14	53	110	1,5	25	10,500	<b>2047 69 2</b>
<b>SBM25 VA</b>	M25x1,5	207	17	59	123	1,5	25	25,000	<b>2047 69 3</b>
<b>SBM32 VA</b>	M32x1,5	245	19	69	144	1,5	25	42,000	<b>2047 69 4</b>
<b>SBM40 VA</b>	M40x1,5	288	19	83	165	1,5	10	65,000	<b>2047 69 5</b>

V2A Stainless steel, grade 304

price/100 pc.

Accessory part: 90° bend, stainless steel, for electrical installation pipes with threaded ends to EN 61386 (Code: 5557).

One connection sleeve is already screwed onto each pipe bend.

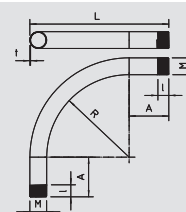

## Metal pipe bend, without thread

Type	Dimen- sion D	Dimen- sion L	Dimen- sion A	Dimen- sion R	Dimen- sion t	Pack.	Weight	Item No.
							pcs	
<b>SB16 VA</b>	16	178	65	97	1,5	10	10,900	<b>2047 68 2</b>
<b>SB20 VA</b>	20	183	53	110	1,5	25	13,800	<b>2047 68 3</b>
<b>SB25 VA</b>	25	207	59	123	1,5	25	19,500	<b>2047 68 4</b>
<b>SB32 VA</b>	32	245	69	165	1,5	25	37,000	<b>2047 68 5</b>
<b>SB40 VA</b>	40	288	83	165	1,5	10	54,600	<b>2047 68 6</b>

V2A Stainless steel, grade 304

price/100 pc.

Accessory part: 90° bend, stainless steel, for electrical installation pipes without threaded ends to EN 61386 (Code: 5557).

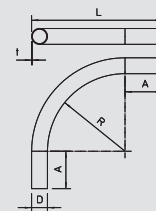

## Metal pipe connection sleeve, with threaded ends

Type	Dimen- sion M	Dimen- sion L	Dimen- sion D	Dimen- sion t	Pack.	Weight	Item No.
						pcs	
<b>SVM16 VA</b>	M16x1,5	32	18,1	1,5	50	2,000	<b>2047 67 3</b>
<b>SVM20 VA</b>	M20x1,5	40	27,1	1,5	50	2,600	<b>2047 67 4</b>
<b>SVM25 VA</b>	M25x1,5	40	27,1	1,5	50	3,800	<b>2047 67 6</b>
<b>SVM32 VA</b>	M32x1,5	44	33,1	1,5	25	5,300	<b>2047 67 7</b>
<b>SVM40 VA</b>	M40x1,5	50	43,3	1,5	25	7,700	<b>2047 67 8</b>

V2A Stainless steel, grade 304

price/100 pc.

Accessory part: Stainless steel pipe connection sleeve with thread to EN 61386 (Code: 5557) to connect electrical installation pipes and 90° bends.

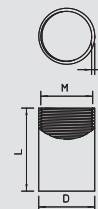

## Metal pipe connection sleeve, without thread

Type	Dimen- sion D	Dimen- sion L	Dimen- sion t	Pack.	Weight	Item No.
					pcs	
<b>SV16 VA</b>	18,6	50	1,05	50	2,100	<b>2047 66 5</b>
<b>SV20 VA</b>	22,6	54	1,05	50	2,800	<b>2047 66 6</b>
<b>SV25 VA</b>	28,3	64	1,25	50	5,300	<b>2047 66 8</b>
<b>SV32 VA</b>	35	74	1,25	25	9,200	<b>2047 66 9</b>
<b>SV40 VA</b>	44	95	1,25	25	12,200	<b>2047 67 0</b>

V2A Stainless steel, grade 304

price/100 pc.

Accessory part: Stainless steel pipe connection sleeve without thread to EN 61386 (Code: 5557) to connect electrical installation pipes and 90° bends.

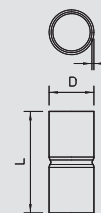

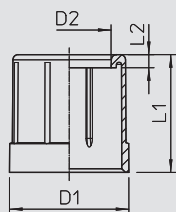

Stapa pipe end bush

Type	Size	Colour	Dimension D1	Dimension D2	Dimension L1	Dimension L2	Shipping box	Pack.	Weight	Item No.
			mm	mm	mm	mm	pcs	pcs	kg/100 pcs.	
<b>129 M16</b>	M16	Light grey	19,4	12,5	18	2	1000	100	0,235	<b>2047 81 0</b>
<b>129 M20</b>	M20	Light grey	23,4	16	22,5	2,5	1200	100	0,326	<b>2047 82 9</b>
<b>129 M25</b>	M25	Light grey	28,4	21	27,5	2,5	600	50	0,614	<b>2047 83 7</b>
<b>129 M32</b>	M32	Light grey	35,4	27,5	34	3	600	50	1,070	<b>2047 85 3</b>
<b>129 M40</b>	M40	Light grey	43,4	35	41	3	50	50	1,444	<b>2047 86 1</b>
<b>129 M50</b>	M50	Light grey	53,4	44,5	48	3	25	25	2,176	<b>2047 88 8</b>
<b>129 M63</b>	M63	Light grey	66,4	55	59	4	25	25	2,808	<b>2047 89 6</b>

PE Polyethylene price/100 pc.

Cable protection connector for attachment to electrical installation pipes to DIN EN 60423 or IEC 423 and other pipes of the same external diameters.

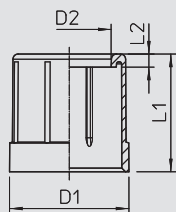

Stapa pipe end bush

Type	Size	Colour	Dimension D1	Dimension D2	Dimension L1	Dimension L2	Shipping box	Pack.	Weight	Item No.
			mm	mm	mm	mm	pcs	pcs	kg/100 pcs.	
<b>129 M16 SW</b>	M16	Black	19,4	12,5	18	2	1000	100	0,235	<b>2047 93 4</b>
<b>129 M20 SW</b>	M20	Black	23,4	16	22,5	2,5	1200	100	0,326	<b>2047 94 2</b>
<b>129 M25 SW</b>	M25	Black	28,4	21	27,5	2,5	600	50	0,614	<b>2047 95 0</b>
<b>129 M32 SW</b>	M32	Black	35,4	27,5	34	3	600	50	1,070	<b>2047 96 9</b>
<b>129 M40 SW</b>	M40	Black	43,4	35	41	3	50	50	1,444	<b>2047 97 7</b>
<b>129 M50 SW</b>	M50	Black	53,4	44,5	48	3	25	25	2,176	<b>2047 98 5</b>
<b>129 M63 SW</b>	M63	Black	66,4	55	59	4	25	25	2,808	<b>2047 99 3</b>

PE Polyethylene price/100 pc.

Cable protection connector for attachment to electrical installation pipes to DIN EN 60423 or IEC 423 and other pipes of the same external diameters.



# Junction box systems



## T 60, plug-in seal

Type	Version	Entries	Colour	Shipping box pcs	Pack. pcs	Weight kg/100 pcs.	Item No.
<b>T 60</b>	Standard	7 x M25	Light grey	60	5	12,300	<b>2007 06 1</b>
<b>T 60 RW</b>	—	7 x M25	Pure white	60	5	12,300	<b>2007 52 5</b>
<b>T 60 F</b>	960 °C flame-resistant	7 x M25	Light grey	60	5	12,300	<b>2007 33 9</b>
<b>T 60 RO-LGR</b>	With red cover	7 x M25	Red grey	60	5	12,300	<b>2007 63 8</b>
<b>T 60 UV RW</b>	UV-resistant	7 x M25	Pure white	60	5	12,300	<b>2007 41 2</b>
<b>T 60 KL</b>	With terminal strip	7 x M25	Light grey	60	5	16,700	<b>2007 43 4</b>

PP Polypropylene price/100 pc.

The junction boxes are made of a thermoplastic polypropylene polymer with plug-in seals made of ethylene vinyl acetate (EVA). This allows installation of cables either directly through the 7 x M25 seals, or the seals can be cut with a knife at the pre-marked points, in order to create an insertion opening for cables or pipes. Alternatively, cable glands can be pushed through the openings instead of the seals and locked with a locknut from the inside.

The junction boxes can be mounted on mounting plates in the openings on the floor using steel screws 3.5 x 9.5.

Clear internal dimensions: 100 x 100 x 48 mm

Cover with labelling panel and lead-sealed.

Standard version: flame-resistant, testing temperature 650 °C.

F version: highly flame-resistant, testing temperature 960 °C.

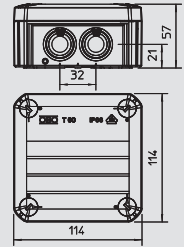

## T 100, plug-in seal

Type	Version	Entries	Colour	Shipping box pcs	Pack. pcs	Weight kg/100 pcs.	Item No.
<b>T 100</b>	Standard	10 x M25	Light grey	40	1	16,270	<b>2007 07 7</b>
<b>T 100 RW</b>	—	10 x M25	Pure white	40	1	16,270	<b>2007 53 3</b>
<b>T 100 F</b>	960 °C flame-resistant	10 x M25	Light grey	40	1	16,270	<b>2007 34 7</b>
<b>T 100 RO-LGR</b>	With red lid	10 x M25	Red grey	40	1	16,270	<b>2007 64 4</b>
<b>T 100 UV RW</b>	UV-resistant	10 x M25	Pure white	40	1	16,500	<b>2007 41 4</b>
<b>T 100 KL</b>	With terminal strip	10 x M25	Light grey	40	1	40,000	<b>2007 43 6</b>

PP Polypropylene price/100 pc.

The junction boxes are made of a thermoplastic polypropylene polymer with plug-in seals made of ethylene vinyl acetate (EVA). This allows installation of cables either directly through the 10 x M25 seals, or the seals can be cut with a knife at the pre-marked points, in order to create an insertion opening for cables or pipes. Alternatively, cable glands can be pushed through the openings instead of the seals and locked with a locknut from the inside.

The junction boxes can be mounted on mounting plates in the openings on the floor using steel screws 3.5 x 9.5.

Clear internal dimensions: 136 x 102 x 57 mm

Cover with labelling panel and lead-sealed.

Standard version: flame-resistant, testing temperature 650 °C.

F version: highly flame-resistant, testing temperature 960 °C.

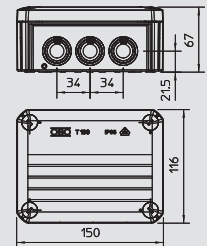

## T 60, closed

Type	Version	Entries	Colour	Shipping box pcs	Pack. pcs	Weight kg/100 pcs.	Item No.
<b>T 60 OE</b>	Closed	None	Light grey	60	5	12,000	<b>2007 23 9</b>

PP Polypropylene price/100 pc.

The junction boxes are made of a thermoplastic polypropylene polymer with closed side walls. This means that the required openings can be made wherever they are required. EDK plug-in seals or cable glands with locknuts can be inserted in these openings, to allow cable insertion. The junction boxes can be mounted on mounting plates in the openings on the floor using steel screws 3.5 x 9.5.

Clear internal dimensions: 100 x 100 x 46 mm

Cover with labelling panel and lead-sealed.

Standard version: flame-resistant, testing temperature 650 °C.

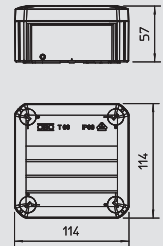

## Plug-in seal for pipes, T series

Type	Size	For Ø mm	Colour	Shipping box pcs	Pack. pcs	Weight kg/100 pcs.	Item No.
<b>EDR 25 16-20 LGR</b>	M25	—	Light grey	50	50	0,520	<b>2011 50 6</b>
<b>EDR 25 20-25 LGR</b>	M25	—	Light grey	50	50	0,680	<b>2011 51 4</b>
<b>EDR 32 20-25 LGR</b>	M32	—	Light grey	50	50	1,020	<b>2011 52 2</b>
<b>EDR 32 25-32 LGR</b>	M32	—	Light grey	50	50	1,170	<b>2011 53 0</b>
<b>EDR 40 25-32 LGR</b>	M40	—	Light grey	25	25	1,950	<b>2011 53 8</b>
<b>EDR 40 32-40 LGR</b>	M40	—	Light grey	25	25	2,200	<b>2011 54 6</b>

PVC Polyvinylchloride price/100 pc.

Plug-in seals are used to run pipes tight to the junction box.

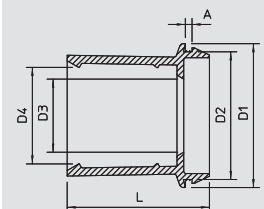



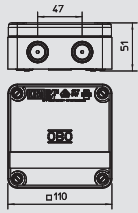

## B 9/T junction box with perforation membrane

Type	Accessories	Colour	Shipping box pcs	Pack. pcs	Weight kg/100 pcs.	Item No.
<b>B 9 T M 5</b>	1 terminal strip	Light grey	40	5	17,500	<b>2001 84 5</b>
<b>B 9 T M</b>	—	Light grey	40	5	13,100	<b>2001 85 3</b>

**PP** Polypropylene price/100 pc.

The wet-room junction boxes comprise two halogen-free plastic components, 8 threaded entries (M20 x 1.5), 1 additional entry in base with perforation membrane (for cable diameter up to 15 mm).

Where cable glands are used (giving additional strain relief) there is no need to remove the membrane (this saves time). Protection IP 67 with cable gland and for the perforation membrane.

Rated voltage 400 V; nominal cross-section 4 - 6 mm<sup>2</sup>.

The cover is sealed with 4 pre-fitted rapid fastenings (180°). The fastening holes are additionally moulded with a soft plastic component for a bolt diameter of 5 mm (spacing 75 mm).

2 fastening bolt caps and 1 fastening bolt.

Clear internal dimensions: 98 x 98 x 40 mm.

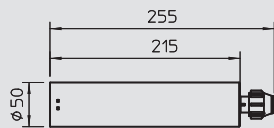

## Aquasit cartridge

Type	Contents ml	Pack. pcs	Weight kg/100 pcs.	Item No.
<b>KVM</b>	250	1	42,000	<b>2363 01 0</b>

/pc.

Aquasit is a two-component casting compound in a cartridge, for applications in areas with continuous and extremely high levels of moisture. It can also be used against mechanical shock and vibrations.

The cartridge is suitable for use in standard cartridge pistols. At room temperature, the unopened aluminium packaging can be stored for up to a year. When the cartridge is opened, the material should be used within 24 hours.

Aquasit properties:

Protection rating: IP68 at 1.8 bar/1,000 h

Rated voltage: 400 V

Penetration resistance: >20 kv/mm to VDE 0291 Part 2

Insulation resistance: > 50 MΩ

Operating temperature: -40 to +90 °C

Processing temperature: 0 to +40 °C

Halogen-free, silicon-free, isocyanate-free

Environmentally friendly and without the need to be labelled

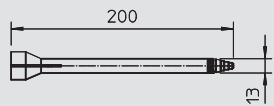

## AQUASIT mixer pipe

Type	Pack. PU	Weight kg/100 PUs	Item No.
<b>KVM-M</b>	1	17,000	<b>2363 01 5</b>

/VPE

10 mixer pipes in the set.

Simple, automatic mixing of OBO AQUASIT when pressing out the compound from the cartridge.

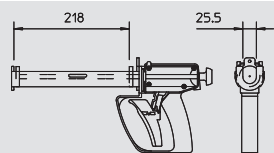

## Aquasit cartridge pistol

Type	Pack. pcs	Weight kg/100 pcs.	Item No.
<b>KVM-P</b>	2	100,000	<b>2363 01 9</b>

/pc.

High-quality one-component cartridge pistol for use with the AQUASIT cold casting compound. The cartridge pistol can also be used with normal 300 ml cartridges.

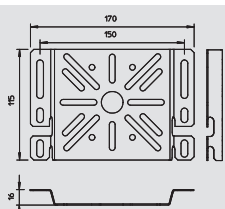

## Mounting plate, T series

Type	Height mm	Width mm	Pack. pcs	Weight kg/100 pcs.	Item No.
<b>MP UNI FS</b>	115	170	40	13,300	<b>7084 77 3</b>

**St** Steel **FS** Strip-galvanised /pc.

Mounting plate, for fastening on the side rail of cable support systems.

Please order the truss-head bolt, type FR5B 6 x 12, separately.



# Junction box systems



## Mounting plate, T series

Type	Height	Width	Pack.	Weight	Item No.
	mm	mm	pcs	kg/100 pcs.	
<b>MP WI KL. FS</b>	210	120	20	20,200	<b>7084 76 5</b>
<b>MP WI KL. DD</b>	210	120	20	20,200	<b>7085 11 1</b>

**St** Steel      **FS** Strip-galvanised      **DD** Zinc-aluminium coated, double-dip      /pc.

Curved mounting plate, for fastening on the side rail of the cable tray.

Please order the truss-head bolt, type FRS B6 x 12, separately.



Type	Dimension A	Dimension B	Dimension x	Dimension y	Pack.	Weight	Item No.
	mm	mm	mm	mm	pcs	kg/100 pcs.	
<b>MPG 65 FT</b>	81	65	45	15	30	9,200	<b>6006 48 6</b>

**St** Steel      **FT** Hot-dip galvanised      /pc.

Mounting for screwless fastening on mesh cable trays.

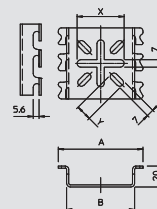
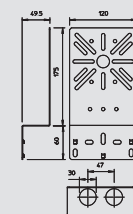

## Hat profile rail

Type	Version	Interface	Material thickness	Length	Pack.	Weight	Item No.
			mm	mm	pcs	kg/100 pcs.	
<b>2069 T350 GTP</b>	For T 350 lengthwise	GTP	1	245	10	8,450	<b>1115 38 8</b>
<b>2069 T160 GTP</b>	For T 160 lengthwise + T 250, T 350 crosswise	GTP	1	157	10	5,520	<b>1115 38 4</b>

**St** Steel      **GTP** Electrogalvanised, transparently passivated      price/100 pc.

Hat profile rail 35 x 7.5 mm to DIN EN 60715 (formerly DIN EN 50022).

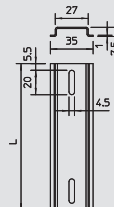

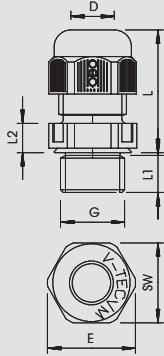

## Cable gland, metric thread



Type	Thread	Colour	Shipping box pcs	Pack.	Weight	Item No.
				pcs	kg/100 pcs.	
V-TEC VM12 LGR	M12 x 1,5	Light grey	500	50	0,318	2022 86 2
V-TEC VM16 LGR	M16 x 1,5	Light grey	500	50	0,638	2022 86 4
V-TEC VM20 LGR	M20 x 1,5	Light grey	600	50	0,856	2022 86 6
V-TEC VM25 LGR	M25 x 1,5	Light grey	300	25	1,360	2022 86 8
V-TEC VM32 LGR	M32 x 1,5	Light grey	240	20	2,230	2022 87 0
V-TEC VM40 LGR	M40 x 1,5	Light grey	120	10	3,467	2022 87 2
V-TEC VM50 LGR	M50 x 1,5	Light grey	60	5	5,466	2022 87 4
V-TEC VM63 LGR	M63 x 1,5	Light grey	60	5	8,306	2022 87 6
V-TEC VM12 SW	M12 x 1,5	Black	500	50	0,318	2022 88 3
V-TEC VM16 SW	M16 x 1,5	Black	500	50	0,638	2022 88 5
V-TEC VM20 SW	M20 x 1,5	Black	600	50	0,856	2022 88 7
V-TEC VM25 SW	M25 x 1,5	Black	300	25	1,360	2022 88 9
V-TEC VM32 SW	M32 x 1,5	Black	240	20	2,230	2022 89 1
V-TEC VM40 SW	M40 x 1,5	Black	120	10	3,467	2022 89 3
V-TEC VM50 SW	M50 x 1,5	Black	60	5	5,466	2022 89 5
V-TEC VM63 SW	M63 x 1,5	Black	60	5	8,306	2022 89 7

PA Polyamide price/100 pc.

The quickest and most convenient way of providing strain relief and tightness with cable glands on junction boxes and housings is with the tried-and-trusted V-TEC VM cable glands from OBO. With the integrated sealing lip and the special OBO lamella technology protection class IP68 (5 bar/ 1 hr.) is achieved. Strain relief and tightness have been tested to DIN EN 50262.

The connecting threads of the cable glands are metric or PG and are therefore suitable for universal use. Once screwed in place, the fitting is there forever, as the optimum thread adjustment with the right pitch ensures permanent resistance to shaking.

Applications: from private housing with junction boxes up to industrial applications in the distributor cabinet.

## Ratchet set

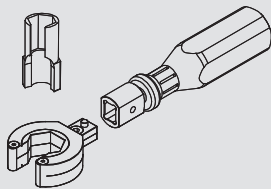

Type	Accessories	Pack.	Weight	Item No.
		pcs	kg/100 pcs.	
V-TEC RA SET	1 ground ratchet 1 grip for ground ratchet 4 socket spanner attachments	1	71,600	3010 27 5

/pc.

Set consisting of a ground ratchet, type V-TEC RA, a grip for ground ratchet, type V-TEC GR, and four socket spanner attachments in sizes WAF 15, WAF 20, WAF 24 and WAF 29.

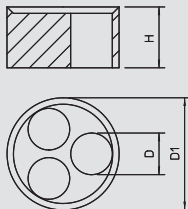

## Multiple sealing insert, metric

Type	Size	Dimension D mm	Dimension H mm	Dimension D1 mm	Number of drill holes	Shipping box pcs	Pack.	Weight	Item No.
							pcs	kg/100 pcs.	
107 C VM 20 2x4	M20	4	8,1	15,1	2	750	50	0,130	2029 67 2
107 C VM 20 4x5	M20	5	8,1	15,1	4	750	50	0,080	2029 67 5
107 C VM 20 2x6	M20	6	8,1	15,1	2	750	50	0,100	2029 67 7
107 C VM 25 5x4	M25	4	10	19,8	5	500	50	0,180	2029 67 9
107 C VM 25 3x6	M25	6	10	19,8	3	500	50	0,210	2029 68 2
107 C VM 25 2x6	M25	6	10	19,8	2	500	50	0,260	2029 68 5
107 C VM 25 3x7	M25	7	10	19,8	3	500	50	0,180	2029 68 8
107 C VM 25 2x8	M25	8	10	19,8	2	500	50	0,200	2029 69 0
107 C VM 32 2x8	M32	8	13,4	25,1	2	500	25	0,530	2029 69 3
107 C VM 32 4x8	M32	8	13,4	25,1	4	500	25	0,400	2029 69 6

NBR-SBR Rubber mixture price/100 pc.

Use to insert multiple thin cables in the V-TEC VM cable glands, is replaced with the simple sealing ring of the cable gland.

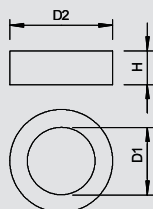

## Reducing seal insert, metric

Type	Size	Sealing range D mm	Dimension D1 mm	Dimension D2 mm	Dimension H mm	Shipping box pcs	Pack.	Weight	Item No.
							pcs	kg/100 pcs.	
107CR VM 12	M12	2-5	5	8,9	7,2	1300	50	0,050	2029 56 0
107CR VM 16	M16	2,5-7	7	12,7	8,1	1300	50	0,115	2029 56 3
107CR VM 20	M20	4-9	9	16	9,3	1200	50	0,205	2029 56 6
107CR VM 25	M25	6-13	13	20,7	10,5	1200	50	0,340	2029 56 9
107CR VM 32	M32	11-16	16	25,7	12,3	350	25	0,625	2029 57 2
107CR VM 40	M40	12-23	23	33,7	15	300	25	1,140	2029 57 5
107CR VM 50	M50	18-29	29	41,7	18,5	250	25	2,080	2029 57 8
107CR VM 63	M63	29-40	40	54,8	20,2	150	25	3,560	2029 58 1

NBR-SBR Rubber mixture price/100 pc.

Reduces the sealing area D of the cable gland V-TEC VM and V-TEC VM L.



# Cable gland systems, plastic



## Screw plug, metric

Type	Size	Colour	Shipping box pcs	Pack. pcs	Weight kg/100 pcs.	Item No.
107VS VM 5 PA	für M12 / Pg9	Light grey	600	50	0,041	2029 51 1
107VS VM 9 PA	für M16 / Pg13,5	Light grey	750	50	0,090	2029 51 4
107VS VM 12 PA	für M20 / Pg16	Light grey	500	50	0,130	2029 51 7
107VS VM 16 PA	für M25 / Pg21	Light grey	500	50	0,190	2029 52 0
107VS VM 20 PA	für M32 / Pg29	Light grey	300	25	0,250	2029 52 3

PA Polyamide price/100 pc.  
Screw plug for dust-proof and waterproof closure of installed but (as yet) unfilled V-TEC... Cable glands.

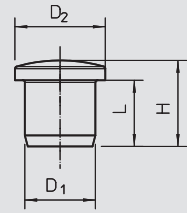

## Screw plug

Type	Thread	Dimension D mm	Dimension L mm	Colour	Shipping box pcs	Pack. pcs	Weight kg/100 pcs.	Item No.
108 M12 PS	M12 x 1,5	15	6	Light grey	3000	100	0,146	2033 00 3
108 M16 PS	M16 x 1,5	20	6	Light grey	1800	100	0,161	2033 00 7
108 M20 PS	M20 x 1,5	24	6	Light grey	1200	100	0,209	2033 01 1
108 M25 PS	M25 x 1,5	30	8	Light grey	1000	100	0,355	2033 01 6
108 M32 PS	M32 x 1,5	37	8	Light grey	500	50	0,352	2033 02 1
108 M40 PS	M40 x 1,5	46	8	Light grey	300	25	1,280	2033 02 6
108 M50 PS	M50 x 1,5	56	10	Light grey	300	25	1,400	2033 03 2
108 M63 PS	M63 x 1,5	70	12	Light grey	300	25	1,850	2033 03 8

PS Polystyrene price/100 pc.  
Screw plug in accordance with DIN 46320, with metric thread to IEC 423.

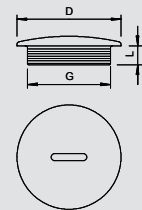

## Locknut, metric thread

Type	Thread	Colour	Shipping box pcs	Pack. pcs	Weight kg/100 pcs.	Item No.
116 M12 LGR PA	M12x1,5	Light grey	2000	100	0,100	2048 90 6
116 M16 LGR PA	M16x1,5	Light grey	1000	100	0,160	2048 91 4
116 M20 LGR PA	M20x1,5	Light grey	1200	100	0,250	2048 92 2
116 M25 LGR PA	M25x1,5	Light grey	1000	100	0,350	2048 93 0
116 M32 LGR PA	M32x1,5	Light grey	500	50	0,610	2048 94 9
116 M40 LGR PA	M40x1,5	Light grey	250	25	1,683	2048 95 7
116 M50 LGR PA	M50x1,5	Light grey	250	25	0,890	2048 96 5
116 M63 LGR PA	M63x1,5	Light grey	200	25	1,830	2048 97 3
116 M12 SW PA	M12x1,5	Black	2000	100	0,100	2049 06 6
116 M16 SW PA	M16x1,5	Black	1000	100	0,160	2049 07 4
116 M20 SW PA	M20x1,5	Black	1200	100	0,250	2049 08 2
116 M25 SW PA	M25x1,5	Black	1000	100	0,350	2049 09 0
116 M32 SW PA	M32x1,5	Black	500	50	0,610	2049 10 4
116 M40 SW PA	M40x1,5	Black	250	25	1,683	2049 11 2
116 M50 SW PA	M50x1,5	Black	250	25	1,756	2049 12 0
116 M63 SW PA	M63x1,5	Black	200	25	1,830	2049 13 9

PA Polyamide price/100 pc.  
Locknut DIN 46319, with metric thread IEC 423.

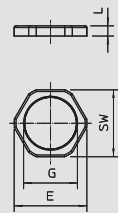

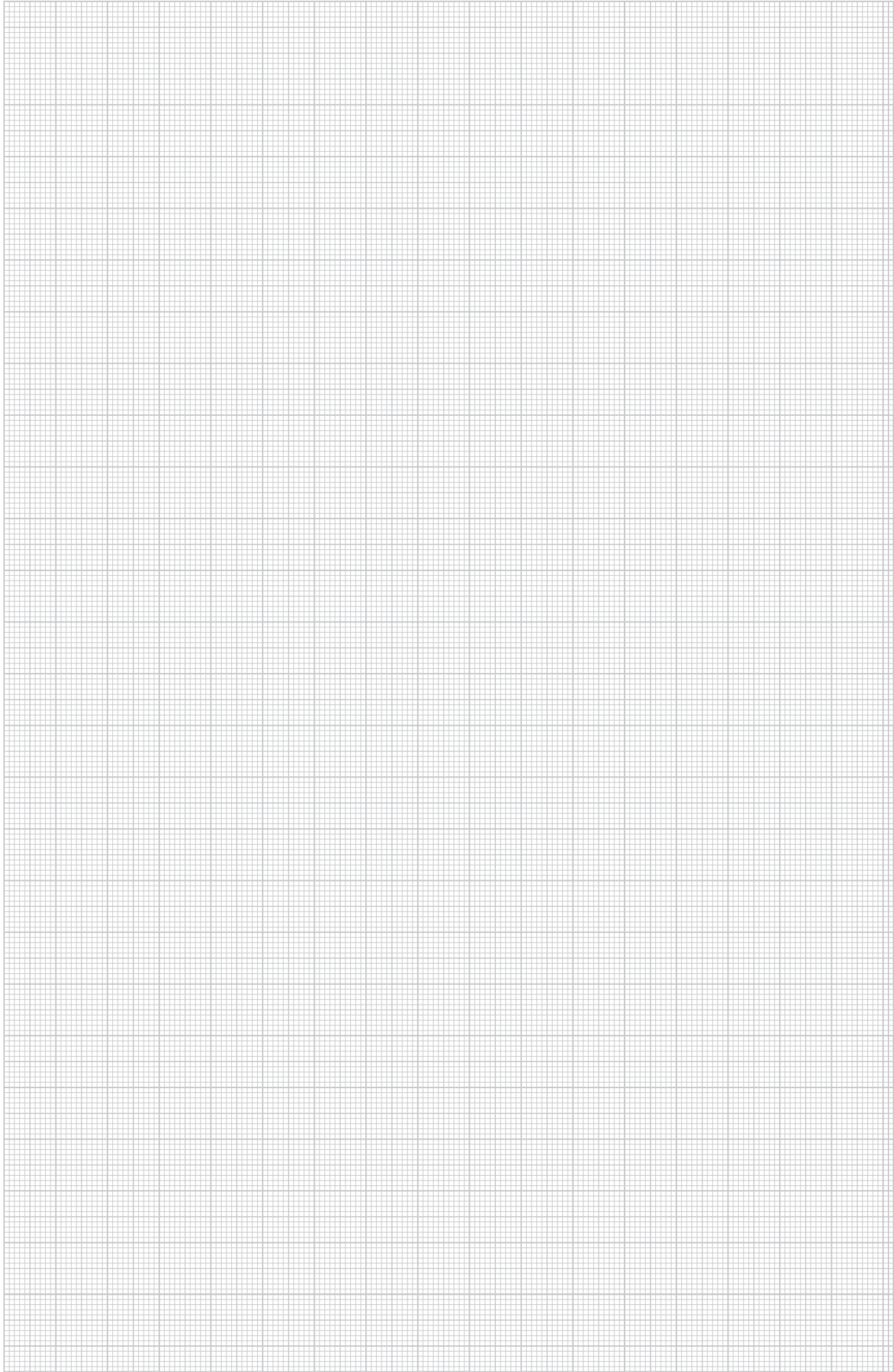









## Construction fire protection

	Insulation: HSM mortar ballast	116
	Insulation: Pyrosit fire protection foam	117
	Insulation: FBA foam series	118
	Waterproof bandage	119
	Fire protection ducts	120

## Insulation: HSM mortar ballast



### HSM mortar in a bucket

Type	Contents	Pack.	Weight	Item No.
	kg	pcs	kg/100 pcs.	
<b>HSM-E1</b>	3,5	1	390,000	<b>7206 03 8</b>
<b>HSM-E2</b>	10,5	1	1130,000	<b>7206 05 4</b>

Special mortar /pc.

Wall ballast, dry mortar in a bucket Free of fibres, halogens and phenols, suitable for pumping, pressing and for manual installation. Fire resistance class S120, DIBt approval Z-19.15-262



### HSM-SP filler

Type	Dimension	Pack.	Weight	Item No.
		pcs	kg/100 pcs.	
<b>HSM-SP</b>	310ml	20	55,000	<b>7205 10 4</b>

Intumescent material /pc.

Fire protection filler in cartridge to form an insulating layer, to fill residual joints for retroinstallations in the HSM hard ballast system. The fire protection must be stored so that it is protected from frost. At storage temperatures between +5 °C and +35 °C, the filler can be stored for at least six months.



### Universal identification plate

Type	Pack.	Weight	Item No.
	pcs	kg/100 pcs.	
<b>KS-S DE</b>	1	2,400	<b>7205 42 5</b>

/pc.

Universal identification plate to be written on for all OBO insulation. For approved identification, including two push-fit anchors.

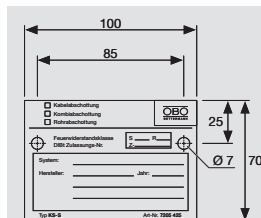

## Insulation: Pyrosit fire protection foam

### FBS90-S fire protection foam

Type	Dimension	Pack.	Weight	Item No.
		pcs	kg/100 pcs.	
<b>FBS90-S</b>	310ml	1	57,000	<b>7208 22 1</b>

/pc.

PYROSIT 2-component fire protection foam in a cartridge, fire resistance class S90. DiBt approval Z-19.15-1894. Including 2 mixing tubes. In dry, frost-free rooms, the fire protection foam can be stored for up to nine months at a temperature of +5 °C to +30 °C. Always process with cartridge pistol FBS90-P2!

Note: The 2-component cartridge pistol, type FP520, can still be used.



### FBS90-P2 cartridge pistol

Type	Pack.	Weight	Item No.
	pcs	kg/100 pcs.	
<b>FBS90-P2</b>	2	117,000	<b>7208 22 5</b>

/pc.

High-quality 2-component cartridge pistol for use with the PYROSIT FBS90 fire protection foam. The cartridge pistol can also be used with normal 300 ml cartridges.



### FBS90-M mixer pipe set

Type	Pack.	Weight	Item No.
	PU	kg/100 PUs	
<b>FBS90-M</b>	1	10,000	<b>7208 23 3</b>

/VPE

10 mixing tubes and 5 extension tubes in the set for Pyrosit FBS90 fire protection foam.



### Universal identification plate

Type	Pack.	Weight	Item No.
	pcs	kg/100 pcs.	
<b>KS-S DE</b>	1	2,400	<b>7205 42 5</b>

/pc.

Universal identification plate to be written on for all OBO insulation. For approved identification, including two push-fit anchors.

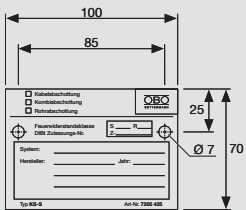

# Insulation: FBA foam series



## FBA-B200 foam block

Type	Dimension mm	Pack. pcs	Weight kg/100 pcs.	Item No.
<b>FBA-B200</b>	200 x 120 x 60	20	40,000	<b>7202 50 6</b>

Permanently elastic, closed-pore foam /pc.

Foam block for combination insulation, fire resistance class S90, DIBt approval Z-19.15-1849. Protect the blocks against water in order to guarantee safe foaming in case of fire.

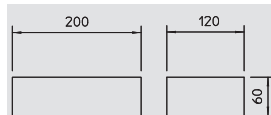

## FBA-BV200 vacuum block

Type	Dimension mm	Pack. pcs	Weight kg/100 pcs.	Item No.
<b>FBA-BV200</b>	200 x 120 x 25	10	40,000	<b>7202 51 6</b>

Permanently elastic, closed-pore foam /pc.

Vacuum block for combination insulation. On cutting the film, the vacuum block expands to its original size. Can be used with or without film. Protect the blocks against water in order to guarantee safe foaming in case of fire.

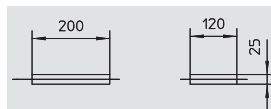

## FBA-SR pipe shell

Type	For opening Ø mm	Pack. pcs	Weight kg/100 pcs.	Item No.
<b>FBA-SR</b>	140	4	73,000	<b>7202 58 6</b>

Permanently elastic, closed-pore foam /pc.

Pipe shell, fire resistance classes S30 and S90, DIBt approval Z-19.15-1558. Scope of delivery: 1 two-part pipe shell Ø 140 mm, 2 plugs FBA-S107

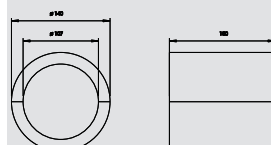

## FBA-S plug

Type	For opening Ø mm	Dimension D mm	Dimension d mm	Pack. pcs	Weight kg/100 pcs.	Item No.
<b>FBA-S107</b>	107	117	107	20	19,000	<b>7202 55 9</b>

Permanently elastic, closed-pore foam /pc.

Plug, fire resistance classes S30 and S90, DIBt approval Z-19.15-1558. Protect the FBA plugs against water in order to guarantee safe foaming in case of fire.

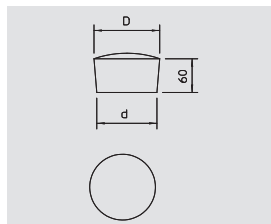

## FBA-F box insulation

Type	Dimension mm	Pack. pcs	Weight kg/100 pcs.	Item No.
<b>FBA-F</b>	200 x 200 x 100	1	122,000	<b>7202 66 0</b>

Permanently elastic, closed-pore foam /pc.

Box with inlays, fire resistance classes S30 and S90, DIBt approval Z-19.15-1557. Scope of delivery: 1 two-part frame, 2 internal pieces

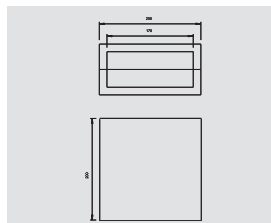

## FBA-SP filler

Type	Dimension	Pack. pcs	Weight kg/100 pcs.	Item No.
<b>FBA-SP</b>	310ml	1	46,000	<b>7202 32 2</b>

Intumescent material /pc.

Fire protection filler in a cartridge. Usable as small insulation in a FBA-SP system, fire resistance class S90, DIBt approval Z-19.15-1851, and as joint closing compound in all insulation of the FBA series. In dry, frost-free rooms, the fire protection compound can be stored at temperatures of +5 °C to +30 °C for up to 12 months.

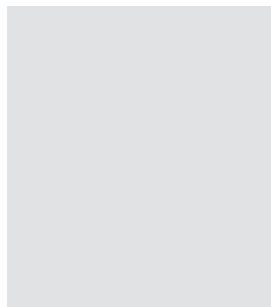

## Universal identification plate

Type	Pack. pcs	Weight kg/100 pcs.	Item No.
<b>KS-S DE</b>	1	2,400	<b>7205 42 5</b>

/pc.

Universal identification plate to be written on for all OBO insulation. For approved identification, including two push-fit anchors.

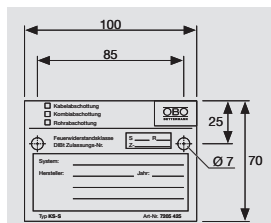



## Fire protection cover, weatherproof

Type	Dimension	Pack.	Weight	Item No.
		pcs	kg/100 pcs.	
<b>FSB-WB</b>	1100x20000	1	2200,000	<b>7203 16 0</b>

/pc.

Waterproof fire protection jacketing made of flexible mesh with fire protection coating to prevent fire spreading via cables and cable support systems. External side grey, internal side red. One roll contains 22 m<sup>2</sup>.



## Tightening strap

Type	Dimension B	Dimension L	Pack.	Weight	Item No.
	mm	mm	pcs	kg/100 pcs.	
<b>FSB-SB</b>	15	50000	1	110,000	<b>7203 13 0</b>

**St** Steel /pc.

Roll of lightweight, galvanised tightening strap, for universal fastening.



## Tightening strap lock

Type	Dimension B	Dimension H	Dimension t	Pack.	Weight	Item No.
	mm	mm	mm	pcs	kg/100 pcs.	
<b>FSB-SV</b>	24	26	0,9	50	0,340	<b>7203 13 2</b>

**St** Steel price/100 pc.

Tightening strap lock with buckle, for simple fixing of the tightening straps FSB-SB.



## Securing clip

Type	Dimension B	Dimension H	Pack.	Weight	Item No.
	mm	mm	pcs	kg/100 pcs.	
<b>FSB-SC</b>	34	16	50	0,180	<b>7203 13 4</b>

**V2A** Stainless steel, grade 304 price/100 pc.

Stainless steel clip to secure the bend tightening strap. Provides secure prevention of removal from the lock.



## Ribbon clip 7 mm

Type	Dimension B	Dimension L	Pack.	Weight	Item No.
	mm	mm	pcs	kg/100 pcs.	
<b>MBS 015</b>	7	150	100	0,230	<b>7203 10 0</b>
<b>MBS 030</b>	7	300	100	0,399	<b>7203 10 2</b>
<b>MBS 045</b>	7	450	50	0,602	<b>7203 10 4</b>
<b>MBS 061</b>	7	610	50	0,806	<b>7203 10 6</b>

**V2A** Stainless steel, grade 304 price/100 pc.

Metal ribbon clip in ladder form with single lock, 7 mm wide in various fixed lengths. For high-temperature and weatherproof fixing.



## Ribbon clip 12 mm

Type	Dimension B	Dimension L	Pack.	Weight	Item No.
	mm	mm	pcs	kg/100 pcs.	
<b>MBS 075</b>	12	750	25	2,300	<b>7203 10 8</b>
<b>MBS 100</b>	12	1000	25	3,000	<b>7203 11 0</b>
<b>MBS 120</b>	12	1200	25	3,600	<b>7203 11 2</b>
<b>MBS 150</b>	12	1500	25	4,400	<b>7203 11 4</b>

**V2A** Stainless steel, grade 304 price/100 pc.

Metal ribbon clip in ladder form with single lock, 12 mm wide in various fixed lengths. For high-temperature and weatherproof fixing.



## Spring chuck for metal strip clips

Type	Pack.	Weight	Item No.
	pcs	kg/100 pcs.	
<b>MBS-Z</b>	1	55,500	<b>7203 12 0</b>

**St** Steel /pc.

High-quality spring chuck with cutting tool for metal strip clips, type MBS.



## Fire protection ducts



### BSK fire protection duct I90/E30, for direct wall and ceiling mounting, internal height 50 mm

Type	Dimension B mm	Dimension H mm	Dimension h mm	Dimension b mm	Length mm	Weight kg/100 m	Item No.
<b>BSK 090506</b>	120	95	50	60	1000	730,000	<b>7215 15 0</b>
<b>BSK 090511</b>	170	95	50	110	1000	940,000	<b>7215 15 4</b>
<b>BSK 090521</b>	270	95	50	210	1000	1350,000	<b>7215 15 8</b>
<b>BSK 091016</b>	220	150	105	160	1000	1430,000	<b>7215 16 2</b>
<b>BSK 091026</b>	320	150	105	260	1000	1830,000	<b>7215 16 6</b>

Glass-fibre lightweight concrete

/m

Fire protection duct I90/I30, to DIN 4102 Part 11 and Part 12, incl. 12 x countersunk head screws and 3 x 1 m sealing strip.

Surface treatment:

The surface of the OBO BSK fire protection trunking allows almost any secondary treatment. Wallpapering, painting and panelling allows harmonious integration of the fire protection trunking into the architecture. This does not impair the fire protection classification of the OBO BSK fire protection trunking.

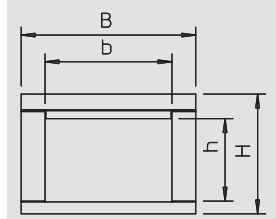

### BSKH fire protection duct I90/E30, for suspended mounting, internal height 50 mm

Type	Dimension B mm	Dimension H mm	Dimension b mm	Dimension h mm	Length mm	Weight kg/100 m	Item No.
<b>BSKH 090506</b>	120	110	60	50	1000	915,000	<b>7215 17 3</b>
<b>BSKH 090511</b>	170	110	110	50	1000	1195,000	<b>7215 17 7</b>
<b>BSKH 090521</b>	270	110	210	50	1000	1640,000	<b>7215 18 1</b>
<b>BSKH 091016</b>	220	165	160	105	1000	1705,000	<b>7215 18 5</b>
<b>BSKH 091026</b>	320	165	260	105	1000	2245,000	<b>7215 18 9</b>

Glass-fibre lightweight concrete

/m

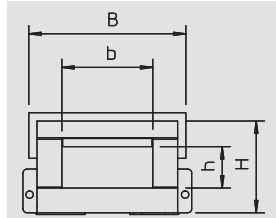

Fire protection duct BSKH I90/E30, suspended, flammable on four sides, to DIN 4102 Part 11 and Part 12, for installation on OBO mounting systems. Including mounted connector on both duct ends, 3x 1 m self-adhesive sealing strip and connecting bolts.

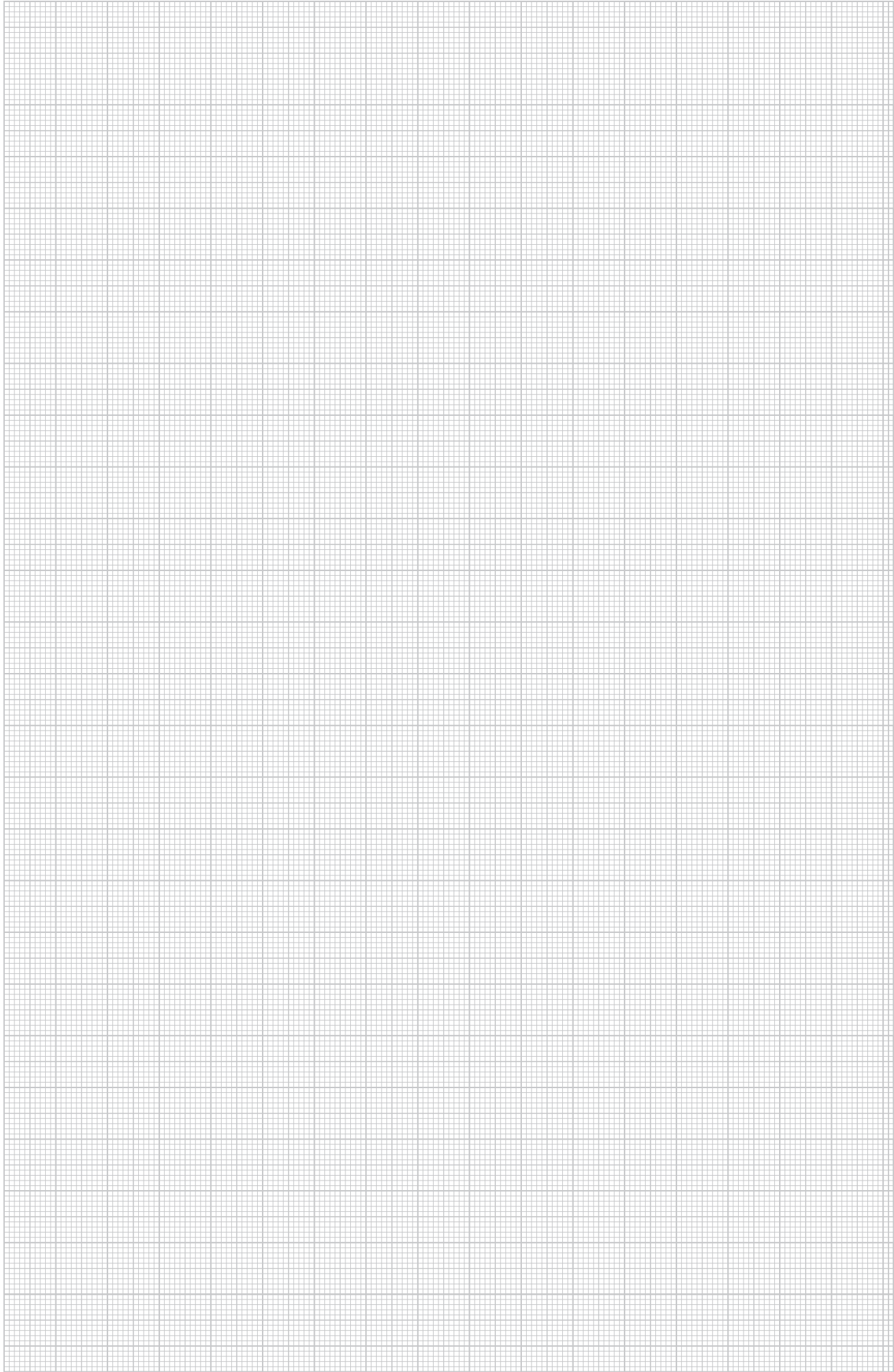





## Directories

	Alphabetical table of contents	124
	Numerical directory	126
	Type listing	130



# Alphabetical table of contents

## 9

90° bend, 85, 105

## A

Angle connector, 85  
Aquisit cartridge, 109  
Aquisit cartridge pistol, 109  
AQUASIT mixer pipe, 109  
Articulated connector, 85

## B

B 9/T junction box with perforation membrane, 109  
Basement area, 66  
Basement area, VDE-tested, 66  
Bridging cable, 68

## C

Cable and pipe spacer clip, 103  
Cable bracket, 42  
Cable gland, metric thread, 111  
Clamping piece, 80  
Clamping piece for separating retainer fastening, 79, 84  
Complete photovoltaic block V20, 1,000 V DC, 55-55  
Complete photovoltaic block V20, 1,000 V DC with FS, 55-55  
Complete photovoltaic block V20, 600 V DC, 54-54  
Complete photovoltaic block V20, 600 V DC with FS, 54-54  
Complete photovoltaic block V25, 900 V DC, 53-53  
Complete photovoltaic block V25, 900 V DC with FS, 53-53  
Complete photovoltaic block V50, 600 V DC, 52-52  
Complete photovoltaic block V50, 600 V DC with FS, 52-52  
Connection and end piece with connector, 43  
Connection and expansion strip, 68  
Connection components – crossbar Rd 16 mm, 68  
Connection components – crossbar Rd 8–10 mm, 68  
Connection sleeve, 105  
Connection terminal, 73  
Connection terminal for interception tip, 43  
Connector for separating retainer, 79, 84  
Connectors, 43  
Construction clamp, 43  
Cover clamp, 82  
Cover for 90° bend, 86  
Cover for mounting/branch piece, 86  
Cover with sash lock, 86  
Cross-connectors, 72

## D

Diagonal clamp, 73  
Duct, type WDK-H 30045, 95  
Duct, type WDK-H 40060, 96  
Duct, type WDK-H 40061, 97  
Duct, type WDK-H 60090, 98  
Duct, type WDK-H 60110, 99  
Duct, type WDK-H 60150, 100

## E

Earth entry rod, tapered and partially insulated, 73  
Earthing clip, 80  
Earthing fixed point, 73  
Earthing screw, 80  
End piece, 95-100  
External corner hood, 95-100

## F

FangFix Junior System, 40  
Fastening clip, heavy-duty, 104  
Fastening clip, medium-duty 5–18 mm, 104  
Flat angle hood, 95-100

## G

Galvanised steel flat conductor, 72

## H

Hat profile rail, 110  
Heavy-duty vertical ladder, 87

## I

Industrial area, 67  
Industrial area accessories, 67  
Industrial area cover, 67  
Inner corner hood, 95-100  
Insulated lightning protection, 43  
Insulated spacer, 41  
Insulated spacer – pipe mounting, 41  
Insulated spacer – wall mounting, 42  
Interception rod – tapered, 40  
Interception rod holder – ridge tiles, 41  
Interception rod holder – sloping roof, 41  
isCon® arrester, 44  
isCon® connection element, 44  
isCon® flat roof cable holder, 44  
isCon® insulation removal pliers, 44  
isCon® M-Quick cable bracket PA, 44  
isCon® PA roof cable holder, sloping roof, 45  
isCon® potential connection, 44  
isCon® spacer, 45  
isCon® Star-Quick clip, 45  
isCon® VA cable bracket, 44  
isCon® VA roof cable holder, sloping roof, 45

## J

Joint connector, 79

## L

Lightning arrester for AC energy technology, 48-48  
Lightning current and surge arrester for AC energy, 49-49  
technology  
Lightning current and surge arrester for AC energy, 49-49  
technology with FS  
Locknut, metric thread, 112

## M

Medium-duty vertical ladder, 87  
Mesh cable tray GR-Magic®, 76-78  
Metal pipe bend, with threaded ends, 106  
Metal pipe bend, without thread, 106  
Metal pipe connection sleeve, with threaded ends, 106  
Metal pipe connection sleeve, without thread, 106  
Metal pipe, with threaded ends, 105  
Metal pipe, without thread, 106  
MKS cable tray, 84  
Mounting adapter for mesh cable trays on stand, 82  
systems  
Mounting plate, 81  
Mounting plate, T series, 109-110  
Mounting/branch piece, 85  
Multiple sealing insert, metric, 111

## O

Outdoors, 66

## P

Photovoltaic cover – lightning and surge arresters, 62-62  
Photovoltaic cover – surge arresters, 62-62  
Photovoltaic housing 900 V DC with connection, 59-59  
terminals with FS  
Photovoltaic housing for WR with 2 MPP trackers, 57-57  
Photovoltaic housing for WR with 3 MPP trackers, 57-57  
Photovoltaic housing with 4 fuses, 56-56  
Photovoltaic housing with 4 terminals, 56-56

## P

Photovoltaic housing with 6 fuses, 56-56  
 Photovoltaic housing with 600 V DC connection, 59-59  
 terminals with FS  
 Photovoltaic housing with connection terminals, 58-58  
 Photovoltaic housing with connection terminals, Type, 58-58  
 1+2, 600 V DC  
 Photovoltaic housing with connection terminals, Type, 58-58  
 1+2, 900 V DC  
 Photovoltaic housing with connection terminals, Type 2,, 58-58  
 1,000 V DC  
 Photovoltaic system solution, Type 1+2, with MC, 60-60  
 connector, 600 V DC  
 Photovoltaic system solution, Type 1+2, with MC, 60-60  
 connector, 900 V DC  
 Photovoltaic system solution, Type 2, with MC, 60-60  
 connector, 1,000 V DC  
 Photovoltaic system solution, Type 2, with MC, 60-60  
 connector, 600 V DC  
 Plastic corrosion protection strip, 73  
 Plug-in seal for pipes, T series, 108  
 Protective cap, 89, 91  
 PV base, 2-pole in Y circuit, 63-63  
 PV base, 2-pole in Y circuit with remote signalling, 63-63  
 PV base, 3-pole in Y circuit, 63-63  
 PV base, 3-pole in Y circuit with remote signalling, 63-63

## Q

Quick Clip, 101  
 Quick Clip, flame-resistant, 101  
 Quick connector, 80  
 Quick duct shears, 105  
 Quick Pipe, 105

## R

Ratchet set, 111  
 Reducing seal insert, metric, 111  
 RKSM cable tray, 83  
 Roof cable holder, 42  
 Roof cable holder – recyclable, 43  
 Round conductor, aluminium, 40  
 Round conductor, galvanised steel, 72  
 Round conductor, stainless steel, 40, 72

## S

Screw plug, 112  
 Screw plug, metric, 112  
 Separating retainer, 79, 84  
 Spacer clamp, 88  
 Spring chuck, 82  
 Stainless steel flat conductor, 72  
 Stand – FangFix system 10 kg, 41, 82  
 Stand – FangFix system 16 kg, 40, 82  
 Stapa pipe end bush, 107  
 starQuick clip, 102  
 starQuick nut, 102  
 Straight connector, 84  
 Surge arrester for AC energy technology, 50-50  
 Surge arrester for AC energy technology with FS, 50-50  
 Surge arrester for data technology – PoE, 51-51  
 Surge arrester for HF applications, 51-51  
 Surge arrester for MCR circuits, 51-51  
 Surge arrester for telecommunications technology, 51-51  
 Surge arrester, photovoltaic system solution, 61-61

## T

T 100, plug-in seal, 108  
 T 60, closed, 108  
 T 60, plug-in seal, 108  
 T and intersection hood, 95-100

## T

T piece, 105  
 Terminal block, 69  
 Tightening strap for cover fastening, 81  
 Tightening strap in fixed lengths, 81  
 Tightening strap lock, 81

## U

Unperforated cover, 81  
 US 3 suspended support, 88-89  
 US 5 suspended support, 90-91

## V

VA terminal block, 69  
 Vario quick connector, 72  
 Vario quick connector Alu, 42, 68  
 Vario quick connector VA, 42, 69

## W

Wall and floor fastener, 81  
 Wall and support bracket AW 15, 92  
 Wall and support bracket AW 30, 94  
 Wall and support bracket AWG 15, 93

# Numeric directory

Structure of the GTIN: Country code **40** Manufacturer code **1219** Individual GTIN **5647589**

GTIN	Art. no.	Price	Page	GTIN	Art. no.	Price	Page	GTIN	Art. no.	Price	Page	GTIN	Art. no.	Price	Page
		price/100				price/100				price/100				price/100	
5007456	1009 02 8		104	5246848	2007 23 9		108	5622437	2047 66 9		106	5586159	2149 36 3		101
5007517	1009 03 6		104	5286509	2007 33 9		108	5622444	2047 67 0		106	5586395	2149 36 9		101
5007579	1009 04 4		104	5286547	2007 34 7		108	5622475	2047 67 3		106	5586456	2149 37 5		101
5007630	1009 05 2		104	5441090	2007 41 2		108	5622482	2047 67 4		106	5587835	2149 38 1		101
5007692	1009 06 0		104	5441106	2007 41 4		108	5622499	2047 67 6		106	5616276	2149 55 9		101
5007753	1009 07 9		104	5441182	2007 43 4		108	5622505	2047 67 7		106	5616337	2149 56 3		101
5007814	1009 08 7		104	5441212	2007 43 6		108	5622512	2047 67 8		106	5616399	2149 56 7		101
5007876	1009 10 9		104	5286660	2007 52 5		108	5622543	2047 68 2		106	5616450	2149 57 1		101
5007937	1009 11 7		104	5286677	2007 53 3		108	5622550	2047 68 3		106	5616511	2149 57 5		101
5007999	1009 16 8		104	5303275	2007 63 8		108	5622567	2047 68 4		106	5616993	2149 57 9		101
5008057	1009 18 4		104	5303282	2007 64 4		108	5622574	2047 68 5		106	5617051	2149 58 3		101
5008118	1009 19 2		104					5622581	2047 68 6		106				
5008170	1009 20 6		104	5246909	2011 50 6		108	5622611	2047 69 0		106			/pc.	
5008231	1009 21 4		104	5246916	2011 51 4		108	5622628	2047 69 2		106	5028154	2153 57 2		105
				5246923	2011 52 2		108	5622635	2047 69 3		106			price/100	
5015130	1015 09 5		104	5246930	2011 53 0		108	5622642	2047 69 4		106	5505396	2153 78 7		44
5015192	1015 11 7		104	5246947	2011 53 8		108	5622659	2047 69 5		106			/pc.	
5015253	1015 13 3		104	5246954	2011 54 6		108	5490753	2047 81 0		107	5509950	2153 82 9		105
5015314	1015 16 8		104					5490692	2047 82 9		107	5469391	2153 83 1		105
5015376	1015 21 4		104					5490630	2047 83 7		107	5510017	2153 83 3		105
5015437	1015 30 3		104	5533177	2022 86 2		111	5487692	2047 85 3		107	5510079	2153 83 5		105
5015499	1015 36 2		104	5533238	2022 86 4		111	5037699	2047 86 1		107	5510130	2153 86 4		105
5015550	1015 42 7		104	5533658	2022 86 6		111	5037637	2047 88 8		107	5469452	2153 86 6		105
5015611	1015 48 6		104	5533719	2022 86 8		111	5037576	2047 89 6		107	5510192	2153 86 8		105
5567615	1015 49 4		104	5533771	2022 87 0		111	5468851	2047 93 4		107	5510253	2153 87 0		105
5567738	1015 49 6		104	5533832	2022 87 2		111	5468912	2047 94 2		107	5510314	2153 87 2		105
5567790	1015 49 8		104	5533894	2022 87 4		111	5468974	2047 95 0		107	5469575	2153 87 4		105
5567851	1015 50 0		104	5533955	2022 87 6		111	5469155	2047 96 9		107	5510376	2153 87 6		105
5567912	1015 50 8		104	5534013	2022 88 3		111	5469216	2047 97 7		107	5510437	2153 87 8		105
				5535638	2022 88 5		111	5469278	2047 98 5		107			price/100	
5441007	1115 38 4		110	5535690	2022 88 7		111	5469339	2047 99 3		107	5028093	2153 90 4		105
5441045	1115 38 8		110	5535751	2022 88 9		111					5027799	2153 91 2		105
				5538219	2022 89 1		111					5025214	2153 92 0		105
5114499	1360 05 1		103	5538332	2022 89 3		111	5874157	2048 90 6		112	5025153	2153 93 9		105
5114550	1360 08 6		103	5538455	2022 89 5		111	5874218	2048 91 4		112				
5114611	1360 10 8		103	5538516	2022 89 7		111	5944539	2048 92 2		112			/pc.	
5114673	1360 12 4		103					5944591	2048 93 0		112				
5114734	1360 14 0		103	5389934	2029 51 1		112	5944652	2048 94 9		112	5230533	2360 05 5		73
5114796	1360 15 9		103	5389941	2029 51 4		112	5088998	2048 95 7		112	5230595	2360 10 1		73
5114857	1360 16 7		103	5389972	2029 51 7		112	5089056	2048 96 5		112				
5114918	1360 18 3		103	5389989	2029 52 0		112	5089117	2048 97 3		112	5577768	2363 01 0		109
5114970	1360 20 5		103	5389996	2029 52 3		112							/VPE	
5115038	1360 22 1		103	5360582	2029 56 0		111	5089179	2049 06 6		112	5686354	2363 01 5		109
5115090	1360 24 8		103	5360599	2029 56 3		111	5095354	2049 07 4		112			/pc.	
5115151	1360 26 4		103	5360605	2029 56 6		111	5095415	2049 08 2		112	5687771	2363 01 9		109
5115212	1360 28 0		103	5360636	2029 56 9		111	5095538	2049 09 0		112				
5115274	1360 30 2		103	5360643	2029 57 2		111	5095651	2049 10 4		112	5034278	3010 27 5		111
5115335	1360 33 7		103	5360650	2029 57 5		111	5095712	2049 11 2		112				
5115397	1360 35 3		103	5360667	2029 57 8		111	5096313	2049 12 0		112	5378259	5015 07 3		66
5115458	1360 38 8		103	5360698	2029 58 1		111	5127758	2049 13 9		112	5959427	5015 11 1		66
5115519	1360 39 6		103	5035831	2029 67 2		111					5378556	5015 65 0		66
5115571	1360 42 6		103	5035893	2029 67 5		111					5002277	5015 85 4		67
5115632	1360 45 0		103	5035954	2029 67 7		111	5595359	2146 05 3		102	5002284	5015 86 6		67
5115694	1360 48 5		103	5036012	2029 67 9		111	5595410	2146 06 1		102	5033615	5015 88 0		67
5115755	1360 50 7		103	5036074	2029 68 2		111	5595472	2146 09 6		102	5033677	5015 88 4		67
5115878	1360 60 4		103	5036135	2029 68 5		111	5595533	2146 11 8		102	5033738	5015 89 0		67
5569114	1360 63 9		103	5036197	2029 68 8		111	5595656	2146 13 4		102				
				5036258	2029 69 0		111	5655367	2146 16 4		45			price/100	
5029755	1361 09 1		103	5036319	2029 69 3		111	5595717	2146 20 7		102	5800477	5018 70 6		72
5029762	1361 09 4		103	5036371	2029 69 6		111	5595779	2146 21 5		102				
5029809	1361 09 7		103					5595830	2146 25 8		102	5680482	5019 34 7		72
5029816	1361 10 0		103	5409274	2033 00 3		112	5204275	2146 29 0		102				
5029823	1361 10 3		103	5424031	2033 00 7		112	5595892	2146 32 0		102	5381617	5021 10 3		72
5029861	1361 10 6		103	5426554	2033 01 1		112	5204398	2146 36 3		102	5680529	5021 23 5		40
5029878	1361 10 9		103	5426615	2033 01 6		112	5595953	2146 44 4		102	5680567	5021 23 9		40
5029885	1361 11 2		103	5431299	2033 02 1		112	5204510	2146 48 7		102	5381914	5021 28 6		40
5254348	1361 11 5		103	5434177	2033 02 6		112	5016069	2146 50 9		102	5901273	5021 29 4		40
5615651	1361 11 7		103	5452478	2033 03 2		112	5016113	2146 51 1		102	5381976	5021 30 8		40
5254386	1361 11 8		103	5464778	2033 03 8		112					5680574	5021 64 4		40
												5680581	5021 64 7		40
5116714	1362 01 1		103					5583219	2149 00 4		101				
5116776	1362 03 8		103					5583936	2149 01 0		101			price/100	
5116837	1362 04 6		103	5622246	2047 65 0		106	5583998	2149 01 6		101	5386056	5043 10 7		80
5116899	1362 05 4		103	5622											

GTIN	Art. no.	Price	Page	GTIN	Art. no.	Price	Page	GTIN	Art. no.	Price	Page	GTIN	Art. no.	Price	Page
5709008	5088 67 6	/pc.	60	5423379	5331 01 3	price/100	68	6021956	6002 44 3	/m	78	6064212	6063 86 1	/m	84
5709015	5088 67 8		60	5423430	5331 50 1		68	6022076	6002 44 5		78	6064274	6063 88 8		84
5613701	5088 69 1		58				58	5149620	6002 45 1		78				
5613718	5088 69 2		58	5105619	5401 98 0		40	5149637	6002 45 7		78			price/100	
5613725	5088 69 3		58	5107774	5401 98 3		40	5149644	6002 46 0		78	6441372	6065 60 0		82
5371090	5088 69 4		58	5108672	5401 98 6		40	5149675	6002 46 3		78	6617050	6065 61 0		82
5835646	5088 69 5		59	5108733	5401 98 9		40	5149682	6002 46 6		40				
5835653	5088 69 6		59	5045359	5401 99 3		40				40				
5473206	5088 69 9		61	5050803	5401 99 5		40				40				
												6066018	6067 65 4	/pc.	84
5478546	5093 62 3		52	5738428	5403 10 0		82	6933259	6006 48 6		81	6066070	6067 66 2		85
5709022	5093 62 5		52	5070054	5403 10 3		41	6933310	6006 48 7		81	5694724	6067 97 0		79
5478553	5093 62 8		52	5070078	5403 11 7		82	6933372	6006 48 8		81				
5709060	5093 62 9		52	5070085	5403 12 4		82	6933433	6006 48 9		81				
5688426	5093 65 3		49	5548713	5403 20 0		40					5237402	6175 00 8	/m	95
5425120	5093 65 4		49	5548898	5403 22 7		82	6146116	6010 46 6		87	5237419	6175 01 4		96
5688433	5093 66 1		49	5548959	5403 23 5		82	6146178	6010 47 4		87	5237426	6175 02 0		97
5425137	5093 66 2		49				82	6146239	6010 48 2		87	5237457	6175 02 6		98
5708841	5093 72 6		62	5034872	5403 30 8	/pc.	40	6146291	6010 49 0		87	5237464	6175 03 2		99
				5613572	5403 33 0		41	6168859	6010 50 4		87	5237471	6175 03 8		100
5709077	5094 57 2		54	5813903	5403 33 3		41	5434047	6010 63 0		87				
5648482	5094 57 4		55	5670735	5403 33 5		41	5434085	6010 63 2		87	5237488	6175 05 1	/pc.	95
5709084	5094 57 6		54					5434092	6010 63 4		87	5237495	6175 05 7		96
5708872	5094 60 5		55	5674573	5408 00 2	price/100	44	5434108	6010 63 6		87	5237501	6175 06 3		97
5478621	5094 60 8		55	5674627	5408 00 4		44	5434146	6010 63 8		87	5237518	6175 06 9		98
5708889	5094 61 3		54				44					5237525	6175 07 5		99
5709114	5094 61 5		55									5237532	6175 08 1		100
5478669	5094 61 7		55	5674634	5408 00 9	/pc.	44	6042845	6015 64 8		88	5237549	6175 10 3		95
5382973	5094 65 0		50	5674689	5408 02 2		44	6042968	6015 65 6		88	5237556	6175 10 9		96
5240099	5094 65 6		50					6043088	6015 66 0		88	5237563	6175 11 5		97
5382911	5094 76 0		50	5674719	5408 03 6		44	6043200	6015 66 4		88	5237570	6175 12 1		98
5240242	5094 76 5		50					6043323	6015 67 2		88	5237587	6175 12 7		99
				5674863	5408 04 3		45	6043446	6015 69 1		88	5237594	6175 13 3		100
5464457	5096 63 7		63	5674870	5408 04 7		45	5239260	6015 69 5		88	5237631	6175 15 6		95
5464464	5096 63 9		63	5674887	5408 04 9		45	5239284	6015 69 9		88	5237648	6175 16 2		96
5648499	5096 64 6		63	5699668	5408 05 6		44					5237655	6175 16 8		97
5299455	5096 64 7		63	5542773	5408 80 6		41	6013036	6016 42 1		81	5237662	6175 17 4		98
5077077	5096 87 7		48	5542834	5408 81 4		41	6013159	6016 63 4		79	5237693	6175 18 0		99
5077091	5096 87 9		48	5004608	5408 84 9		41	6013210	6016 64 2		79	5237709	6175 18 6		100
				5009733	5408 85 2		42	5694069	6016 67 6		80	5237716	6175 20 4		95
5708896	5097 06 5		62	5613329	5408 97 6		43	6054251	6016 68 4		80	5237723	6175 21 0		96
5478683	5097 44 7		53					6054312	6016 68 8		80	5237730	6175 21 6		97
5709121	5097 44 8		53	5900498	5420 00 8		73	6013395	6016 82 0		80	5237747	6175 22 2		98
5478690	5097 45 7		53	5629290	5420 01 6		73	6013456	6016 83 9		80	5237754	6175 22 8		99
5709138	5097 45 8		53									5237778	6175 23 4		100
				5901457	5430 01 1		73	6013579	6017 04 5		80	5237785	6175 25 5		95
5406884	5098 43 1		51	5901570	5430 06 2		73	6013630	6017 06 1		80	5237815	6175 26 1		96
5578352	5098 57 5		51									5237822	6175 26 7		97
												5237839	6175 27 3		98
5708902	5099 61 1		62			/m		5706083	6047 61 3		83	5237846	6175 27 9		99
5708933	5099 70 8		62	5650591	6000 05 4		76	5706120	6047 63 2		83	5237877	6175 28 5		100
				5467700	6000 05 5		76	5706144	6047 64 0		83				
				5467731	6000 05 6		76	5706182	6047 65 6		83				
		price/100		5470724	6000 05 7		76	5706205	6047 69 1		83	5668039	6338 45 8		89
5404774	5207 33 9		42	5470731	6000 05 9		76	5706243	6047 72 1		83	5668046	6338 46 2		91
5404897	5207 44 4		42	5624820	6000 06 9		76	5706267	6047 73 7		83				
				5037200	6000 07 1		76								
5408734	5218 67 5		42	5037231	6000 07 2		76	6031818	6052 82 1		81	6477135	6341 35 8		91
5408857	5218 69 1		42	5037248	6000 07 3		76	6031931	6052 82 4		81	6644230	6341 36 2		91
		/pc.		5037255	6000 07 5		76	6031993	6052 82 8		81	6350292	6341 36 6		91
5674580	5218 88 2		44					6032051	6052 83 1		81	6350414	6341 37 0		91
		price/100		5430933	6001 07 0		77	6032174	6052 83 4		81	6350711	6341 39 0		91
5625889	5218 99 7		43	6101290	6001 07 2		77	6032235	6052 83 7		81	6350834	6341 39 8		91
				6101351	6001 07 4		77	6032297	6052 84 1		81				
				6101412	6001 07 6		77	6032358	6052 84 4		81	6536771	6341 52 7		90
5415879	5304 10 5		43	6101771	6001 07 8		77	6058877	6052 87 8		86	6536719	6341 53 5		90
5416357	5304 40 7		43	6102198	6001 08 0		77	6058938	6052 89 4		86	6536658	6341 54 3		90
5416418	5304 50 4		43	6102259	6001 08 2		77	6058990	6052 90 8		86	6536597	6341 55 1		90
5503057	5304 52 0		43	6102310	6001 08 5		77	6059058	6052 93 2		86	6536535	6341 57 8		90
5416951	5304 97 0		43	5430940	6001 41 5		77	6059119	6052 95 9		86	6536474	6341 58 6		90
				6814879	6001 41 6		77	6059171	6052 97 5		86	6536412	6341 59 4		90
				6078912	6001 41 8		77					6536351	6341 60 8		90
5737063	5311 50 3		68	6814930	6001 42 0		77	5694502	6062 05 2		79	6536290	6341 61 6		90
5417736	5311 51 9		42	5045281	6001 42 1		77	5694557	6062 08 4		84	6536238	6341 62 4		90
5417910	5311 55 1		42	6815050	6001 42 4		77	5694601	6062 17 3		79	6536177	6341 63 2		90
5693789	5311 57 3		68	6815111	6001 42 8		77								
5466192	5311 58 5		68	6018062	6001 43 0		77	5694618	6062 28 0	price/100	84	6224470	6342 35 1		88
				6815173	6001 43 2		77	5694625	6062 28 2		79	6224531	63		



# Numeric directory

Structure of the GTIN: Country code **40** Manufacturer code **1219** Individual GTIN **5647589**

GTIN	Art. no.	Price	Page	GTIN	Art. no.	Price	Page
6225439	<b>6342 37 2</b>	/pc.	88	6146895	<b>7084 77 3</b>	/pc.	109
5705352	<b>6342 40 1</b>		89	5163305	<b>7085 11 1</b>		110
5705369	<b>6342 40 3</b>		89				
5705376	<b>6342 40 5</b>		89	6820870	<b>7134 12 2</b>		85
5705383	<b>6342 40 7</b>		89	6820931	<b>7134 13 0</b>		85
5705390	<b>6342 40 9</b>		89	6820993	<b>7134 13 8</b>		85
5705406	<b>6342 41 1</b>		89	6254712	<b>7134 23 1</b>		85
5705413	<b>6342 41 3</b>		89	6254774	<b>7134 25 8</b>		85
5705420	<b>6342 41 5</b>		89	6254835	<b>7134 26 6</b>		85
5705437	<b>6342 41 7</b>		89	6254897	<b>7134 90 8</b>		86
				6254958	<b>7134 91 6</b>		86
		price/100		6255016	<b>7134 92 4</b>		86
6049080	<b>6404 00 6</b>		80	6255078	<b>7134 93 2</b>		86
6049202	<b>6404 01 4</b>		80	6255139	<b>7134 94 0</b>		86
				6255191	<b>7134 96 7</b>		86
				6821235	<b>7136 12 0</b>		85
6206599	<b>6419 70 4</b>	/pc.	94	6821297	<b>7136 13 3</b>		85
6206650	<b>6419 71 2</b>		94	6821358	<b>7136 14 1</b>		85
6206711	<b>6419 72 0</b>		94	6256877	<b>7136 24 2</b>		85
6206773	<b>6419 74 7</b>		94	6256938	<b>7136 25 0</b>		85
6206834	<b>6419 76 3</b>		94	6256990	<b>7136 26 9</b>		85
6206896	<b>6419 79 8</b>		94	6257058	<b>7136 90 0</b>		86
6206957	<b>6419 82 8</b>		94	6257119	<b>7136 91 9</b>		86
				6257171	<b>7136 92 7</b>		86
6483730	<b>6419 83 6</b>		94	6257232	<b>7136 93 5</b>		86
				6257294	<b>7136 94 3</b>		86
6207015	<b>6419 84 4</b>		94	6257355	<b>7136 97 8</b>		86
6662470	<b>6420 60 6</b>		93	5428190	<b>7202 32 2</b>		
6079155	<b>6420 60 7</b>		93	5428206	<b>7202 50 6</b>		
6662531	<b>6420 60 8</b>		93	5428220	<b>7202 51 6</b>		
6662593	<b>6420 61 0</b>		93	6142330	<b>7202 55 9</b>		
6662654	<b>6420 61 2</b>		93	6142699	<b>7202 58 6</b>		
6662715	<b>6420 61 4</b>		93	6144013	<b>7202 66 0</b>		
6662777	<b>6420 61 6</b>		93				
5058373	<b>6420 62 5</b>		93			price/100	
5058380	<b>6420 62 8</b>		93	5693345	<b>7203 10 0</b>		
5058427	<b>6420 63 1</b>		93	5693352	<b>7203 10 2</b>		
5058434	<b>6420 63 4</b>		93	5693369	<b>7203 10 4</b>		
5058502	<b>6420 63 7</b>		93	5693376	<b>7203 10 6</b>		
5058540	<b>6420 64 0</b>		93	5693383	<b>7203 10 8</b>		
				5693390	<b>7203 11 0</b>		
6207077	<b>6420 65 6</b>		92	5693406	<b>7203 11 2</b>		
6207138	<b>6420 66 4</b>		92	5693413	<b>7203 11 4</b>		
6207190	<b>6420 68 0</b>		92			/pc.	
6207251	<b>6420 71 0</b>		92	5693420	<b>7203 12 0</b>		
6207312	<b>6420 74 5</b>		92	5693437	<b>7203 13 0</b>		
6207374	<b>6420 78 8</b>		92			price/100	
6207435	<b>6420 79 6</b>		92	5693444	<b>7203 13 2</b>		
6207497	<b>6420 82 6</b>		92	5726425	<b>7203 13 4</b>		
						/pc.	
6207558	<b>6421 00 8</b>		92	5706434	<b>7203 16 0</b>		
6207619	<b>6421 02 4</b>		92	6263653	<b>7205 10 4</b>		
6207671	<b>6421 03 2</b>		92	5448259	<b>7205 42 5</b>		
5061953	<b>6421 03 6</b>		92				
5061960	<b>6421 04 0</b>		92	6263899	<b>7206 03 8</b>		
5061977	<b>6421 04 4</b>		92	6263950	<b>7206 05 4</b>		
6208937	<b>6442 80 3</b>		94	5650904	<b>7208 22 1</b>		
6209057	<b>6442 83 8</b>		94	5650911	<b>7208 22 5</b>		
6209118	<b>6442 85 4</b>		94			/VPE	
6209170	<b>6442 87 0</b>		94	5650935	<b>7208 23 3</b>		
6209231	<b>6442 89 7</b>		94				
6209293	<b>6442 91 9</b>		94			/m	
				6024834	<b>7215 15 0</b>		
				6024957	<b>7215 15 4</b>		
		price/100		6025077	<b>7215 15 8</b>		
6498079	<b>6490 02 6</b>	price/100	81	6025190	<b>7215 16 2</b>		
				6025312	<b>7215 16 6</b>		
6209538	<b>6490 10 7</b>		81	5077800	<b>7215 17 3</b>		
6209590	<b>6490 12 3</b>		81	5077817	<b>7215 17 7</b>		
6209651	<b>6490 15 8</b>		81	5077824	<b>7215 18 1</b>		
6209712	<b>6490 17 4</b>		81	5077855	<b>7215 18 5</b>		
6209835	<b>6490 96 4</b>		81	5077862	<b>7215 18 9</b>		
6209897	<b>6498 01 9</b>	/pc.	82				
6230839	<b>7082 25 8</b>		85				
6146833	<b>7084 76 5</b>		110				

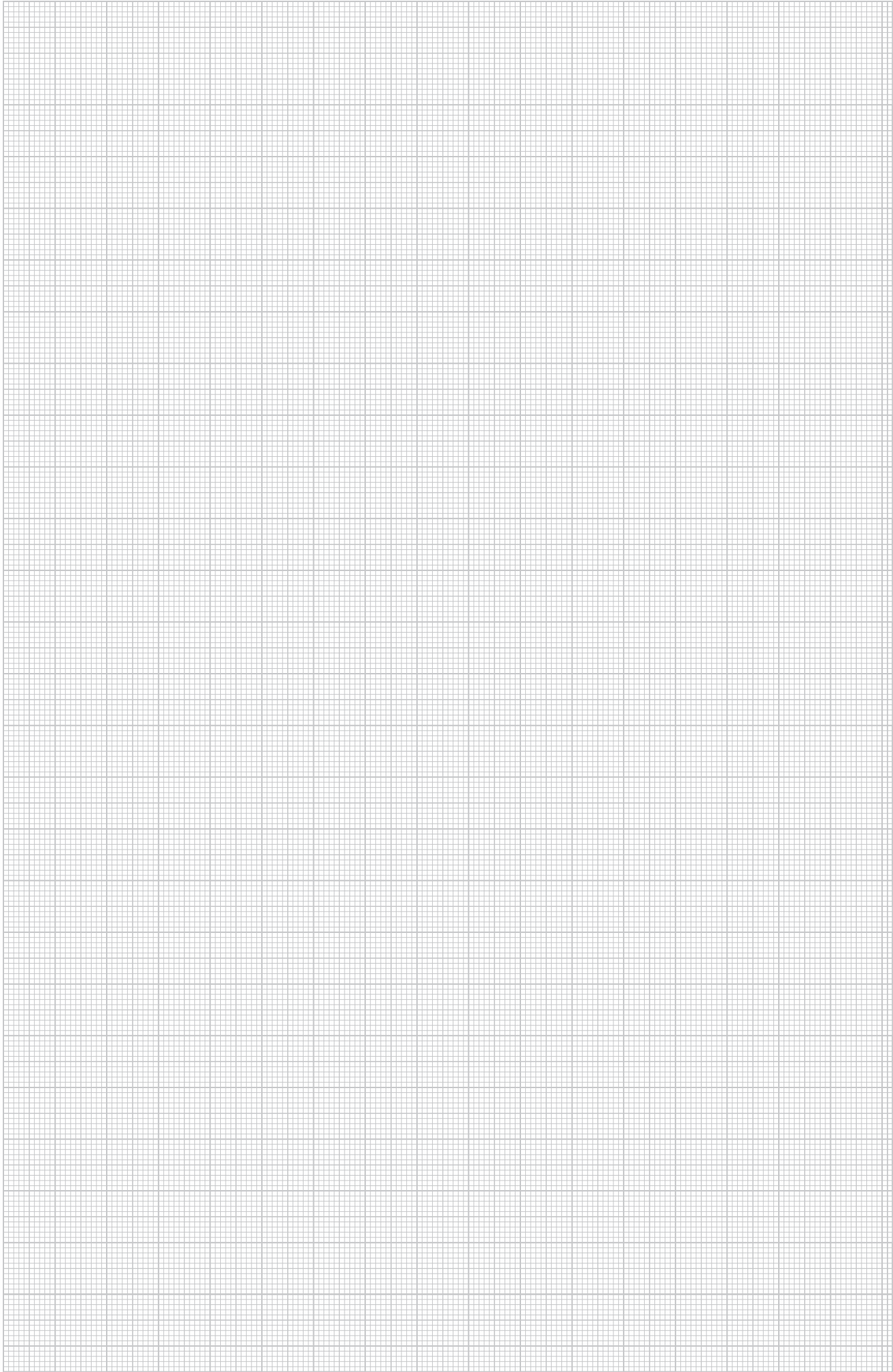



# Type listing

Structure of the GTIN: Country code **40** Manufacturer code **1219** Individual GTIN **5647589**

Type	Dimensions/Colour/Div.	GTIN	Art. no.	Price	Page	Type	Dimensions/Colour/Div.	GTIN	Art. no.	Price	Page
101 3-ES-16	750	5613329	5408 97 6	/pc.	43	177 20 M8	/ PA	5404897	5207 44 4	price/100	42
				price/100		177 20 VA M6	/ V2A	5404774	5207 33 9		42
101 VL1500	1500 / AI	5105619	5401 98 0		40						
101 VL2000	2000 / AI	5107774	5401 98 3		40						
101 VL2500	2500 / AI	5108672	5401 98 6		40	197 VA4301	1800 / V2A	6209835	6490 96 4		81
101 VL3000	3000 / AI	5108733	5401 98 9		40						
101 VL3500	3500 / AI	5045359	5401 99 3		40						
101 VL4000	4000 / AI	5050803	5401 99 5		40						
										/pc.	
						204 KS-2000	/ St / F	5901457	5430 01 1		73
						204 KS-2500	/ St / F	5901570	5430 06 2		73
107 C VM 20 2x4	M204 / NBR-SBR	5035831	2029 67 2		111						
107 C VM 20 2x6	M206 / NBR-SBR	5035954	2029 67 7		111	205 B-M10 VA	M10 / V4A	5900498	5420 00 8		73
107 C VM 20 4x5	M205 / NBR-SBR	5035893	2029 67 5		111	205 B-M12 VA	M12 / V4A	5629290	5420 01 6		73
107 C VM 25 2x6	M256 / NBR-SBR	5036135	2029 68 5		111						
107 C VM 25 2x8	M258 / NBR-SBR	5036258	2029 69 0		111					price/100	
107 C VM 25 3x6	M256 / NBR-SBR	5036074	2029 68 2		111	249 8-10 ALU	44 / AI	5417736	5311 51 9		42
107 C VM 25 3x7	M257 / NBR-SBR	5036197	2029 68 8		111	249 8-10 ALU	44 / AI	5417736	5311 51 9		68
107 C VM 25 5x4	M254 / NBR-SBR	5036012	2029 67 9		111	249 8-10 ALU-OT	/ AI	5466192	5311 58 5		68
107 C VM 32 2x8	M328 / NBR-SBR	5036319	2029 69 3		111	249 8-10 ST-OT	/ St / FT	5737063	5311 50 3		68
107 C VM 32 4x8	M328 / NBR-SBR	5036371	2029 69 6		111	249 8-10 VA	40 / V2A	5417910	5311 55 1		42
						249 8-10 VA	40 / V2A	5417910	5311 55 1		69
						249 8-10 VA	40 / V2A	5417910	5311 55 1		72
107CR VM 12	M12 / NBR-SBR	5360582	2029 56 0		111	249 VA-OT	/ V2A	5693789	5311 57 3		68
107CR VM 16	M16 / NBR-SBR	5360599	2029 56 3		111						
107CR VM 20	M20 / NBR-SBR	5360605	2029 56 6		111						
107CR VM 25	M25 / NBR-SBR	5360636	2029 56 9		111	250 A-VA	40 / V2A	5740476	5313 02 3		73
107CR VM 32	M32 / NBR-SBR	5360643	2029 57 2		111	250 V4A	/ V4A	5700876	5312 92 5		72
107CR VM 40	M40 / NBR-SBR	5360650	2029 57 5		111						
107CR VM 50	M50 / NBR-SBR	5360667	2029 57 8		111	259 A FT 8-OT	/ St / FT	5737070	5315 51 7		69
107CR VM 63	M63 / NBR-SBR	5360698	2029 58 1		111						
						324 S-VA	/ V2A	5422471	5326 31 1		69
107VS VM 12 PA für M20 / Pg16 Light grey / PA		5389972	2029 51 7		112						
107VS VM 16 PA für M25 / Pg21 Light grey / PA		5389989	2029 52 0		112						
107VS VM 20 PA für M32 / Pg29 Light grey / PA		5389996	2029 52 3		112						
107VS VM 5 PA für M12 / Pg9 Light grey / PA		5389934	2029 51 1		112	356 100	100 10	5230595	2360 10 1	/pc.	73
107VS VM 9 PA für M16 / Pg13,5 Light grey / PA		5389941	2029 51 4		112	356 50	50 10	5230533	2360 05 5		73
108 M12 PS	M12 x 1,5 15 / PS	5409274	2033 00 3		112						
108 M16 PS	M16 x 1,5 20 / PS	5424031	2033 00 7		112					price/100	
108 M20 PS	M20 x 1,5 24 / PS	5426554	2033 01 1		112	574 03 30 BA	17 x 1.0.300 / V2A	6209538	6490 10 7		81
108 M25 PS	M25 x 1,5 30 / PS	5426615	2033 01 6		112	574 03 45 BA	17 x 1.0.450 / V2A	6209590	6490 12 3		81
108 M32 PS	M32 x 1,5 37 / PS	5431299	2033 02 1		112					price/100	
108 M40 PS	M40 x 1,5 46 / PS	5434177	2033 02 6		112	574 03 SW	17 x 1.02,25 / V2A	6498079	6490 02 6		81
108 M50 PS	M50 x 1,5 56 / PS	5452478	2033 03 2		112					price/100	
108 M63 PS	M63 x 1,5 70 / PS	5464778	2033 03 8		112	574 05 55 GNBG	16,5 x 1.2.550 / V2A	6209651	6490 15 8		81
						574 05 65 GNBG	16,5 x 1.2.650 / V2A	6209712	6490 17 4		81
116 M12 LGR PA	M12x1,5 Light grey / PA	5874157	2048 90 6		112						
116 M12 SW PA	M12x1,5 Black / PA	5089179	2049 06 6		112						
116 M16 LGR PA	M16x1,5 Light grey / PA	5874218	2048 91 4		112	575	/ St	6209897	6498 01 9	/pc.	82
116 M16 SW PA	M16x1,5 Black / PA	5095354	2049 07 4		112						
116 M20 LGR PA	M20x1,5 Light grey / PA	5944539	2048 92 2		112						
116 M20 SW PA	M20x1,5 Black / PA	5095415	2049 08 2		112					price/100	
116 M25 LGR PA	M25x1,5 Light grey / PA	5944591	2048 93 0		112	732 10 GTP	9-10 - / St / GTP	5114611	1360 10 8		103
116 M25 SW PA	M25x1,5 Black / PA	5095538	2049 09 0		112	732 12 GTP	10,5-12 M12 / St / GTP	5114673	1360 12 4		103
116 M32 LGR PA	M32x1,5 Light grey / PA	5944652	2048 94 9		112	732 14 GTP	12,5-14 PG7 / St / GTP	5114734	1360 14 0		103
116 M32 SW PA	M32x1,5 Black / PA	5095651	2049 10 4		112	732 15 GTP	13,5-15 PG9 / St / GTP	5114796	1360 15 9		103
116 M40 LGR PA	M40x1,5 Light grey / PA	5088998	2048 95 7		112	732 16 GTP	14,5-16 M16 / St / GTP	5114857	1360 16 7		103
116 M40 SW PA	M40x1,5 Black / PA	5095712	2049 11 2		112	732 18 GTP	16,5-18 PG11 / St / GTP	5114918	1360 18 3		103
116 M50 LGR PA	M50x1,5 Light grey / PA	5089056	2048 96 5		112	732 20 GTP	18,5-20 M20 / St / GTP	5114970	1360 20 5		103
116 M50 SW PA	M50x1,5 Black / PA	5096313	2049 12 0		112	732 22 GTP	20-22 PG13,5 / St / GTP	5115038	1360 22 1		103
116 M63 LGR PA	M63x1,5 Light grey / PA	5089117	2048 97 3		112	732 24 GTP	22-24 PG16 / St / GTP	5115090	1360 24 8		103
116 M63 SW PA	M63x1,5 Black / PA	5127758	2049 13 9		112	732 26 GTP	24-26 M25 / St / GTP	5115151	1360 26 4		103
						732 28 GTP	26-28 PG21 / St / GTP	5115212	1360 28 0		103
						732 30 GTP	28-30 PG21 / St / GTP	5115274	1360 30 2		103
129 M16	M16 Light grey / PE	5490753	2047 81 0		107	732 33 GTP	31-33 M32 / St / GTP	5115335	1360 33 7		103
129 M16 SW	M16 Black / PE	5468851	2047 93 4		107	732 35 GTP	33-35 - / St / GTP	5115397	1360 35 3		103
129 M20	M20 Light grey / PE	5490692	2047 82 9		107	732 38 GTP	36-38 PG29 / St / GTP	5115458	1360 38 8		103
129 M20 SW	M20 Black / PE	5468912	2047 94 2		107	732 40 GTP	38-40 M40 / St / GTP	5115519	1360 39 6		103
129 M25	M25 Light grey / PE	5490630	2047 83 7		107	732 42 GTP	40-42 M40 / St / GTP	5115571	1360 42 6		103
129 M25 SW	M25 Black / PE	5468974	2047 95 0		107	732 45 GTP	43-45 - / St / GTP	5115632	1360 45 0		103
129 M32	M32 Light grey / PE	5487692	2047 85 3		107	732 48 GTP	46-48 PG36 / St / GTP	5115694	1360 48 5		103
129 M32 SW	M32 Black / PE	5469155	2047 96 9		107	732 50 GTP	48-50 M50 / St / GTP	5115755	1360 50 7		103
129 M40	M40 Light grey / PE	5037699	2047 86 1		107	732 6 GTP	5-6 - / St / GTP	5114499	1360 05 1		103
129 M40 SW	M40 Black / PE	5469216	2047 97 7		107	732 60 GTP	58-60 PG48 / St / GTP	5115878	1360 60 4		103
129 M50	M50 Light grey / PE	5037637	2047 88 8		107	732 63 GTP	61-63 M63 / St / GTP	5569114	1360 63 9		103
129 M50 SW	M50 Black / PE	5469278	2047 98 5		107	732 8 GTP	7-8 - / St / GTP	5114550	1360 08 6		103
129 M63	M63 Light grey / PE	5037576	2047 89 6		107						
129 M63 SW	M63 Black / PE	5469339	2047 99 3		107	733 13 FT	11-13 6,5 x 10 / St / FT	5029755	1361 09 1		103
						733 16 FT	14-16 6,5 x 10 / St / FT	5029762	1361 09 4		103
						733 16 VA	14-16 6,5 x 10 / V2A	5116714	1362 01 1		103
						733 19 FT	17-19 6,5 x 10 / St / FT	5029809	1361 09 7		103
						733 19 VA	17-19 6,5 x 10 / V2A	5116776	1362 03 8		103
						733 21 FT	19-21 6,5 x 10 / St / FT	5029816	1361 10 0		103
						733 21 VA	19-21 6,5 x 10 / V2A	5116837	1362 04 6		103
165 MBG-10	/ PE	5408734	5218 67 5		42	733 23 FT	21-23 6,5 x 10 / St / FT	5029823	1361 10 3		103
165 MBG-8	/ PE	5408857	5218 69 1		42	733 23 VA	21-23 6,5 x 10 / V2A	5116899	1362 05 4		103
165 R-8-10	/ PE	5625889	5218 99 7		43	733 29 FT	24-29 6,5 x 10 / St / FT	5029861	1361 10 6		103

12 LPA Lösungskatalog Photovoltaik\_2011\_Neu/en/25/08/2011 (LLEXP01\_01327)

Type	Dimensions/Colour/Div.	GTIN	Art. no.	Price	Page	Type	Dimensions/Colour/Div.	GTIN	Art. no.	Price	Page
733 29 VA	24-29 6,5 x 10/ V2A	5116950	1362 06 2	price/100	103	2955 F M16 RW	M16 Pure white/ PP	5585671	2149 35 1	price/100	101
733 38 FT	30-38 6,5 x 10/ St / FT	5029878	1361 10 9		103	2955 F M16 STGR	M16 Stone grey/ PP	5584353	2149 30 3		101
733 38 VA	30-38 6,5 x 10/ V2A	5117018	1362 07 0		103	2955 F M20 RW	M20 Pure white/ PP	5586036	2149 35 7		101
733 48 FT	39-48 6,5 x 10/ St / FT	5029885	1361 11 2		103	2955 F M20 STGR	M20 Stone grey/ PP	5585251	2149 30 9		101
733 48 VA	39-48 6,5 x 10/ V2A	5117070	1362 08 9		103	2955 F M25 RW	M25 Pure white/ PP	5586159	2149 36 3		101
733 54 FT	48-54 6,5 x 10/ St / FT	5615651	1361 11 7		103	2955 F M25 STGR	M25 Stone grey/ PP	5585312	2149 31 5		101
733 54 VA	48-54 6,5 x 10/ V2A	5117131	1362 09 7		103	2955 F M32 RW	M32 Pure white/ PP	5586395	2149 36 9		101
733 61 FT	53-61 6,5 x 10/ St / FT	5254348	1361 11 5		103	2955 F M32 STGR	M32 Stone grey/ PP	5585435	2149 32 1		101
733 61 VA	53-61 6,5 x 14/ V2A	5117193	1362 10 0		103	2955 F M40 RW	M40 Pure white/ PP	5586456	2149 37 5		101
733 63 FT	63-63 6,5 x 10/ St / FT	5254386	1361 11 8		103	2955 F M40 STGR	M40 Stone grey/ PP	5585497	2149 32 7		101
733 63 VA	63-63 8 x 18/ V2A	5117254	1362 12 7		103	2955 F M50 RW	M50 Pure white/ PP	5587835	2149 38 1		101
						2955 F M50 STGR	M50 Stone grey/ PP	5585558	2149 33 3		101
823 16 FT	16 6,5 x 10/ St / FT	5015130	1015 09 5		104	2955 F M63 STGR	M63 Stone grey/ PP	5585619	2149 33 9		101
823 18.3 FT	18,6 6,5 x 10/ St / FT	5015192	1015 11 7		104	2955 M16	M16 Light grey/ PP	5583219	2149 00 4		101
823 20 FT	20 6,5 x 10/ St / FT	5015253	1015 13 3		104	2955 M16 SW	M16 Jet black/ PP	5616276	2149 55 9		101
823 22.5 FT	22,5 6,5 x 10/ St / FT	5015314	1015 16 8		104	2955 M20	M20 Light grey/ PP	5583936	2149 01 0		101
823 25 FT	25 6,5 x 10/ St / FT	5567615	1015 49 4		104	2955 M20 SW	M20 Jet black/ PP	5616337	2149 56 3		101
823 28.3 FT	28,3 6,5 x 10/ St / FT	5015376	1015 21 4		104	2955 M25	M25 Light grey/ PP	5583998	2149 01 6		101
823 32 FT	32 6,5 x 10/ St / FT	5567738	1015 49 6		104	2955 M25 SW	M25 Jet black/ PP	5616399	2149 56 7		101
823 37 FT	37 6,5 x 10/ St / FT	5015437	1015 30 3		104	2955 M32	M32 Light grey/ PP	5584056	2149 02 2		101
823 40 FT	40 6,5 x 10/ St / FT	5567790	1015 49 8		104	2955 M32 SW	M32 Jet black/ PP	5616450	2149 57 1		101
823 47 FT	47 6,5 x 10/ St / FT	5015499	1015 36 2		104	2955 M40	M40 Light grey/ PP	5584292	2149 02 8		101
823 50 FT	50 6,5 x 10/ St / FT	5567851	1015 50 0		104	2955 M40 SW	M40 Jet black/ PP	5616511	2149 57 5		101
823 54 FT	54 6,5 x 10/ St / FT	5015550	1015 42 7		104	2955 M50	M50 Light grey/ PP	5588191	2149 03 4		101
823 59.3 FT	59,3 6,5 x 10/ St / FT	5015611	1015 48 6		104	2955 M50 SW	M50 Jet black/ PP	5616993	2149 57 9		101
823 63 FT	63 6,5 x 10/ St / FT	5567912	1015 50 8		104	2955 M63	M63 Light grey/ PP	5588252	2149 04 0		101
						2955 M63 SW	M63 Jet black/ PP	5617051	2149 58 3		101
853 300	300/ Al	5423379	5331 01 3		68						
856	/ Cu	5423430	5331 50 1		68	5001 DIN-FT	/ St / FT	5415879	5304 10 5		43
939	150/ St / G	5386056	5043 10 7		80	5004 DIN-FT 12	/ TG / FT	5416357	5304 40 7		43
1015 10 G	102000/ St / G	5007753	1009 07 9		104	5004 DIN-FT 12	/ TG / FT	5416357	5304 40 7		73
1015 11 G	111800/ St / G	5007814	1009 08 7		104	5004 DIN-FT 20	/ TG / FT	5416418	5304 50 4		43
1015 12 G	121000/ St / G	5007876	1009 10 9		104	5004 DIN-FT 20	/ TG / FT	5416418	5304 50 4		43
1015 13 G	131800/ St / G	5007937	1009 11 7		104						
1015 14 G	141200/ St / G	5007999	1009 16 8		104	5010 20 FT	/ St / FT	5503057	5304 52 0		43
1015 15 G	151200/ St / G	5008057	1009 18 4		104						
1015 16 G	161200/ St / G	5008118	1009 19 2		104	5052 DIN 30X3.5	30 x 3,5/ St / FT	5680482	5019 34 7	price/100	72
1015 17 G	171200/ St / G	5008170	1009 20 6		104	5052 V4A 30X3.5	30 x 3,5/ V4A	5800477	5018 70 6		72
1015 18 G	181200/ St / G	5008231	1009 21 4		104						
1015 5 G	53000/ St / G	5007456	1009 02 8		104						
1015 6 G	62400/ St / G	5007517	1009 03 6		104						
1015 7 G	72000/ St / G	5007579	1009 04 4		104	AW 15 11 FT	11050/ St / FT	6207077	6420 65 6	/pc.	92
1015 8 G	82000/ St / G	5007630	1009 05 2		104						
1015 9 G	92000/ St / G	5007692	1009 06 0		104	AW 15 11 VA4301	11050/ V2A	6207558	6421 00 8		92
1801 VDE	Grey/ CuZn	5378556	5015 65 0	/pc.	66	AW 15 16 FT	16055/ St / FT	6207138	6420 66 4		92
1802 10 VA	40/ V2A	5002284	5015 86 6		67	AW 15 21 FT	21060/ St / FT	6207190	6420 68 0		92
1802 5 VA	40/ V2A	5002277	5015 85 4		67	AW 15 21 VA4301	21060/ V2A	6207619	6421 02 4		92
1802 AH 10	/ V2A	5033677	5015 88 4		67	AW 15 31 FT	31065/ St / FT	6207251	6420 71 0		92
1802 AH 5	/ V2A	5033615	5015 88 0		67	AW 15 31 VA4301	31065/ V2A	6207671	6421 03 2		92
1802 KL	/ V2A	5033738	5015 89 0		67						
1809	Grey/ CuZn	5378259	5015 07 3		66	AW 15 41 FT	41070/ St / FT	6207312	6420 74 5		92
1809 A	Black/ V2A	5959427	5015 11 1		66	AW 15 41 VA4301	41070/ V2A	5061953	6421 03 6		92
2069 T160 GTP	/ St / GTP	5441007	1115 38 4	price/100	110	AW 15 51 FT	51075/ St / FT	6207374	6420 78 8		92
2069 T350 GTP	/ St / GTP	5441045	1115 38 8		110	AW 15 51 VA4301	51075/ V2A	5061960	6421 04 0		92
2953 B M16 LGR	M16 Light grey/ PVC	5510130	2153 86 4	/pc.	105	AW 15 56 FT	56080/ St / FT	6207435	6420 79 6		92
2953 B M20 LGR	M20 Light grey/ PVC	5469452	2153 86 6		105	AW 15 61 FT	61080/ St / FT	6207497	6420 82 6		92
2953 B M25 LGR	M25 Light grey/ PVC	5510192	2153 86 8		105	AW 15 61 VA4301	61080/ V2A	5061977	6421 04 4		92
2953 B M32 LGR	M32 Light grey/ PVC	5510253	2153 87 0		105						
2953 M M16 LGR	M16 Light grey/ PVC	5509950	2153 82 9		105						
2953 M M20 LGR	M20 Light grey/ PVC	5469391	2153 83 1		105	AW 30 11 FT	11060/ St / FT	6206599	6419 70 4		94
2953 M M25 LGR	M25 Light grey/ PVC	5510017	2153 83 3		105	AW 30 11 VA4301	11060/ V2A	6208937	6442 80 3		94
2953 M M32 LGR	M32 Light grey/ PVC	5510079	2153 83 5		105						
2953 M16 LGR	M16 Light grey/ PVC	5028093	2153 90 4	price/100	105	AW 30 16 FT	16065/ St / FT	6206650	6419 71 2		94
2953 M20 LGR	M20 Light grey/ PVC	5027799	2153 91 2		105	AW 30 21 FT	21070/ St / FT	6206711	6419 72 0		94
2953 M25 LGR	M25 Light grey/ PVC	5025214	2153 92 0		105						
2953 M32 LGR	M32 Light grey/ PVC	5025153	2153 93 9		105	AW 30 21 VA4301	21070/ V2A	6209057	6442 83 8		94
2953 T M16 LGR	M16 Light grey/ PVC	5510314	2153 87 2	/pc.	105	AW 30 31 FT	31080/ St / FT	6206773	6419 74 7		94
2953 T M20 LGR	M20 Light grey/ PVC	5469575	2153 87 4		105						
2953 T M25 LGR	M25 Light grey/ PVC	5510376	2153 87 6		105	AW 30 31 VA4301	31080/ V2A	6209118	6442 85 4		94
2953 T M32 LGR	M32 Light grey/ PVC	5510437	2153 87 8		105						

# Type listing

Structure of the GTIN: Country code **40** Manufacturer code **1219** Individual GTIN **5647589**

Type	Dimensions/Colour/Div.	GTIN	Art. no.	Price	Page	Type	Dimensions/Colour/Div.	GTIN	Art. no.	Price	Page
AW 30 41 FT	41080/ St / FT	6206834	6419 76 3	/pc.	94	DRL 600 VA4301	600 1,25/ V2A	6059171	6052 97 5	/m	86
AW 30 41 VA4301	41080/ V2A	6209170	6442 87 0		94	DRLU 050 VA4301	50 1/ V2A	6031818	6052 82 1		81
						DRLU 100 VA4301	100 1/ V2A	6031931	6052 82 4		81
AW 30 51 FT	51090/ St / FT	6206896	6419 79 8		94	DRLU 150 VA4301	150 1/ V2A	6031993	6052 82 8		81
						DRLU 200 VA4301	200 1/ V2A	6032051	6052 83 1		81
AW 30 51 VA4301	51090/ V2A	6209231	6442 89 7		94	DRLU 300 VA4301	300 1/ V2A	6032174	6052 83 4		81
						DRLU 400 VA4301	400 1/ V2A	6032235	6052 83 7		81
AW 30 56 FT	560100/ St / FT	6207015	6419 84 4		94	DRLU 500 VA4301	500 1,25/ V2A	6032297	6052 84 1		81
AW 30 61 FT	610100/ St / FT	6206957	6419 82 8		94	DRLU 600 VA4301	600 1,25/ V2A	6032358	6052 84 4		81
AW 30 61 VA4301	610100/ V2A	6209293	6442 91 9		94						
AW 30 71 FT	710100/ St / FT	6483730	6419 83 6		94					price/100	
AW G 15 11 FT	11050/ St / FT	6662470	6420 60 6		93	EDR 25 16-20 LGR	M25/ PVC	5246909	2011 50 6		108
AW G 15 16 FT	16055/ St / FT	6079155	6420 60 7		93	EDR 25 20-25 LGR	M25/ PVC	5246916	2011 51 4		108
AW G 15 21 FT	21060/ St / FT	6662531	6420 60 8		93	EDR 32 20-25 LGR	M32/ PVC	5246923	2011 52 2		108
AW G 15 31 FT	31065/ St / FT	6662593	6420 61 0		93	EDR 32 25-32 LGR	M32/ PVC	5246930	2011 53 0		108
AW G 15 41 FT	41070/ St / FT	6662654	6420 61 2		93	EDR 40 25-32 LGR	M40/ PVC	5246947	2011 53 8		108
AW G 15 41 FT	41070/ St / FT	6662654	6420 61 2		93	EDR 40 32-40 LGR	M40/ PVC	5246954	2011 54 6		108
AW G 15 51 FT	51075/ St / FT	6662715	6420 61 4		93						
AW G 15 61 FT	61080/ St / FT	6662777	6420 61 6		93						
AWG 15 11VA4301	11050/ V2A	5058373	6420 62 5		93	FBA-B200	200 x 120 x 60	5428206	7202 50 6	/pc.	
AWG 15 21VA4301	21060/ V2A	5058380	6420 62 8		93	FBA-BV200	200 x 120 x 25	5428220	7202 51 6		
AWG 15 31VA4301	31065/ V2A	5058427	6420 63 1		93	FBA-F	200 x 200 x 100	6144013	7202 66 0		
AWG 15 41VA4301	41070/ V2A	5058434	6420 63 4		93	FBA-S107	107 117	6142330	7202 55 9		
AWG 15 51VA4301	51075/ V2A	5058502	6420 63 7		93	FBA-SP		5428190	7202 32 2		
AWG 15 61VA4301	61080/ V2A	5058540	6420 64 0		93	FBA-SR	140	6142699	7202 58 6		
B 33020	228/ CuZn	6049080	6404 00 6	price/100	80	FBS90-M		5650935	7208 23 3	/VPE	
B 33021	26 10/ CuZn	6049202	6404 01 4		80	FBS90-P2		5650911	7208 22 5	/pc.	
						FBS90-S		5650904	7208 22 1		
B 9 T M	Light grey/ PP	5540076	2001 85 3		109						
B 9 T M 5	Light grey/ PP	5541936	2001 84 5		109						
BSK 090506	12095	6024834	7215 15 0	/m		F-FIX-10		5070054	5403 10 3	price/100	41
BSK 090511	17095	6024957	7215 15 4			F-FIX-132	/ V2A	5613572	5403 33 0	/pc.	41
BSK 090521	27095	6025077	7215 15 8			F-Fix-132-300	/ V2A	5813903	5403 33 3		41
BSK 091016	220 150	6025190	7215 16 2							price/100	
BSK 091026	320 150	6025312	7215 16 6			F-FIX-16		5548713	5403 20 0		40
BSKH 090506	120 110	5077800	7215 17 3			F-FIX-B10	/ PP	5070085	5403 12 4		82
BSKH 090511	170 110	5077817	7215 17 7			F-FIX-B16	/ PP	5548959	5403 23 5		82
BSKH 090521	270 110	5077824	7215 18 1							/pc.	
BSKH 091016	220 165	5077855	7215 18 5			F-FIX-JUNIOR	1000/ Al	5034872	5403 30 8		40
BSKH 091026	320 165	5077862	7215 18 9			F-FIX-S10		5070078	5403 11 7	price/100	82
						F-FIX-S16		5548898	5403 22 7		82
DBLG 20 050 FT	50/ ST / FT	6042845	6015 64 8	/pc.	88						
DBLG 20 100 FT	100/ ST / FT	6042968	6015 65 6		88					/pc.	
DBLG 20 150 FT	150/ ST / FT	6043088	6015 66 0		88	FRD 24 HF		5578352	5098 57 5		51
DBLG 20 200 FT	200/ ST / FT	6043200	6015 66 4		88						
DBLG 20 300 FT	300/ ST / FT	6043323	6015 67 2		88						
DBLG 20 400 FT	400/ ST / FT	6043446	6015 69 1		88	FSB-SB	1550000/ St	5693437	7203 13 0		
DBLG 20 500 FT	500/ ST / FT	5239260	6015 69 5		88					price/100	
DBLG 20 600 FT	600/ ST / FT	5239284	6015 69 9		88	FSB-SC	34 16/ V2A	5726425	7203 13 4		
						FSB-SV	2426/ St	5693444	7203 13 2		
DFAA 100 VA4301	100 1/ V2A	6257058	7136 90 0		86	FSB-WB		5706434	7203 16 0	/pc.	
DFAA 200 VA4301	200 1/ V2A	6257119	7136 91 9		86						
DFAA 300 VA4301	300 1/ V2A	6257171	7136 92 7		86						
DFAA 400 VA4301	400 1,25/ V2A	6257232	7136 93 5		86						
DFAA 500 VA4301	500 1,25/ V2A	6257294	7136 94 3		86	GKB 34 VA	/ V2A	5694069	6016 67 6		80
DFAA 600 VA4301	600 1,25/ V2A	6257355	7136 97 8		86						
DFB 90 100VA4301	100 1/ V2A	6254897	7134 90 8		86	GKS 34 FT	/ ST / FT	6013395	6016 82 0		80
DFB 90 200VA4301	200 1/ V2A	6254958	7134 91 6		86	GKS 34 VA4301	/ V2A	6013456	6016 83 9		80
DFB 90 300VA4301	300 1/ V2A	6255016	7134 92 4		86						
DFB 90 400VA4301	400 1,25/ V2A	6255078	7134 93 2		86	GKT 38 FT	/ ST / FT	6013630	6017 06 1		80
DFB 90 500VA4301	500 1,25/ V2A	6255139	7134 94 0		86	GKT 38 VA4301	/ V2A	6013579	6017 04 5		80
DFB 90 600VA4301	600 1,25/ V2A	6255191	7134 96 7		86					/m	
						GRM 105 100 FT	1003,9/ St / FT	6021239	6002 43 1		78
						GRM 105 150 FT	1503,9/ St / FT	6021352	6002 43 3		78
DKU 120 VA4310	/ V2A	6617050	6065 61 0	price/100	82	GRM 105 200 FT	2004,8/ St / FT	6021475	6002 43 5		78
DKU 60 VA4310	/ V2A	6441372	6065 60 0		82	GRM 105 300 FT	3004,8/ St / FT	6021598	6002 43 7		78
						GRM 105 400 FT	4004,8/ St / FT	6021710	6002 43 9		78
						GRM 105 450 FT	4504,8/ St / FT	6021833	6002 44 1		78
						GRM 105 500 FT	5004,8/ St / FT	6021956	6002 44 3		78
DRL 100 VA4301	100 1/ V2A	6058877	6052 87 8		86	GRM 105 600 FT	6004,8/ St / FT	6022076	6002 44 5		78
DRL 200 VA4301	200 1/ V2A	6058938	6052 89 4		86	GRM 35 100 FT	1003,9/ St / FT	5037200	6000 07 1		76
DRL 300 VA4301	300 1/ V2A	6058990	6052 90 8		86	GRM 35 100VA4301	1003,9/ V2A	5467700	6000 05 5		76
DRL 400 VA4301	400 1/ V2A	6059058	6052 93 2		86	GRM 35 150 FT	1503,9/ St / FT	5037231	6000 07 2		76
DRL 500 VA4301	500 1,25/ V2A	6059119	6052 95 9		86						

Type	Dimensions/Colour/Div.	GTIN	Art. no.	Price	Page	Type	Dimensions/Colour/Div.	GTIN	Art. no.	Price	Page
GRM 35 150VA4301	150 3,9/ V2A	5467731	6000 05 6	/m	76	MBS 015	7 150/ V2A	5693345	7203 10 0	price/100	
GRM 35 200 FT	200 3,9/ St / FT	5037248	6000 07 3		76	MBS 030	7 300/ V2A	5693352	7203 10 2		
GRM 35 200VA4301	200 3,9/ V2A	5470724	6000 05 7		76	MBS 045	7 450/ V2A	5693369	7203 10 4		
GRM 35 300 FT	300 4,8/ St / FT	5037255	6000 07 5		76	MBS 061	7 610/ V2A	5693376	7203 10 6		
GRM 35 300VA4301	300 4,8/ V2A	5470731	6000 05 9		76	MBS 075	12 750/ V2A	5693383	7203 10 8		
GRM 35 50 FT	50 3,9/ St / FT	5624820	6000 06 9		76	MBS 100	12 1000/ V2A	5693390	7203 11 0		
GRM 35 50VA4301	50 3,9/ V2A	5650591	6000 05 4		76	MBS 120	12 1200/ V2A	5693406	7203 11 2		
GRM 55 100 FT	100 3,9/ St / FT	6814879	6001 41 6		77	MBS 150	12 1500/ V2A	5693413	7203 11 4		
GRM 55 100VA4301	100 3,9/ V2A	6101290	6001 07 2		77						
GRM 55 150 FT	150 3,9/ St / FT	6078912	6001 41 8		77					/pc.	
GRM 55 150VA4301	150 3,9/ V2A	6101351	6001 07 4		77	MBS-Z	/ St	5693420	7203 12 0		
GRM 55 200 4.8FT	200 4,8/ St / FT	5045281	6001 42 1		77						
GRM 55 200 FT	200 3,9/ St / FT	6814930	6001 42 0		77						
GRM 55 200VA4301	200 3,9/ V2A	6101412	6001 07 6		77	MCD 50-B 3		5077077	5096 87 7		48
GRM 55 300 FT	300 4,8/ St / FT	6815050	6001 42 4		77	MCD 50-B 3+1		5077091	5096 87 9		48
GRM 55 300VA4301	300 4,8/ V2A	6101771	6001 07 8		77						
GRM 55 400 FT	400 4,8/ St / FT	6815111	6001 42 8		77	MDP-4 D-24-T		5406884	5098 43 1		51
GRM 55 400VA4301	400 4,8/ V2A	6102198	6001 08 0		77						
GRM 55 450 FT	450 4,8/ St / FT	6018062	6001 43 0		77						
GRM 55 50 FT	50 3,9/ St / FT	5430940	6001 41 5		77					/m	
GRM 55 500 FT	500 4,8/ St / FT	6815173	6001 43 2		77	MKSU 610 VA4301	100 0,8/ V2A	6063970	6063 77 2		84
GRM 55 500VA4301	500 4,8/ V2A	6102259	6001 08 2		77	MKSU 620 VA4301	200 0,8/ V2A	6064038	6063 78 0		84
GRM 55 50VA4301	50 3,9/ V2A	5430933	6001 07 0		77	MKSU 630 VA4301	300 0,8/ V2A	6064090	6063 79 9		84
GRM 55 600 FT	600 4,8/ St / FT	6815234	6001 43 6		77	MKSU 640 VA4301	400 1/ V2A	6064151	6063 84 5		84
GRM 55 600VA4301	600 4,8/ V2A	6102310	6001 08 5		77	MKSU 650 VA4301	500 1/ V2A	6064212	6063 86 1		84
						MKSU 660 VA4301	600 1/ V2A	6064274	6063 88 8		84
GRM105 100VA4301	100 3,9/ V2A	5149620	6002 45 1		78						
GRM105 200VA4301	200 4,8/ V2A	5149637	6002 45 7		78					/pc.	
GRM105 300VA4301	300 4,8/ V2A	5149644	6002 46 0		78	MP UNI FS	115 170/ ST / FS	6146895	7084 77 3		109
GRM105 400VA4301	400 4,8/ V2A	5149675	6002 46 3		78						
GRM105 500VA4301	500 4,8/ V2A	5149682	6002 46 6		78	MP WI KL. DD	210 120/ ST / DD	5163305	7085 11 1		110
						MP WI KL. FS	210 120/ ST / FS	6146833	7084 76 5		110
GRV 245 DD	245/ ST / DD	6054251	6016 68 4	/pc.	80	MPG 65 FT	8165/ ST / FT	6933259	6006 48 6		81
GRV 245 VA4404	245/ V4A	6054312	6016 68 8		80	MPG 65 FT	8165/ ST / FT	6933259	6006 48 6		110
						MPG 65 VA4404	8165/ V4A	6933372	6006 48 8		81
GSV 34 FT	/ ST / FT	6013159	6016 63 4		79	MPG 90 FT	11195/ ST / FT	6933310	6006 48 7		81
GSV 34 VA4301	/ V2A	6013210	6016 64 2		79	MPG 90 VA4404	11195/ V4A	6933433	6006 48 9		81
HSM-E1		6263899	7206 03 8							price/100	
HSM-E2		6263950	7206 05 4			M-Quick M25 SW	20-25 / PA	5505396	2153 78 7		44
HSM-SP		6263653	7205 10 4							/pc.	
ISAV1000R	/ GFK	5004608	5408 84 9		41	ND-CAT6A/EA		5614364	5081 80 0		51
ISAV1000W	/ GFK	5009733	5408 85 2		42						
isCon 750 SW	Black	5674573	5408 00 2	price/100	44	RAA 610 VA4301	100/ V2A	6821235	7136 12 0		85
isCon 750 SW	Black	5674627	5408 00 4		44	RAA 620 VA4301	200/ V2A	6821297	7136 13 3		85
					44	RAA 630 VA4301	300/ V2A	6821358	7136 14 1		85
isCon connect	/ V2A	5674689	5408 02 2	/pc.	44	RAAU 640 VA4301	400/ V2A	6256877	7136 24 2		85
isCon DH	23-26 / GFK	5674863	5408 04 3		45	RAAU 650 VA4301	500/ V2A	6256938	7136 25 0		85
isCon H VA	/ V2A	5699668	5408 05 6		44	RAAU 660 VA4301	600/ V2A	6256990	7136 26 9		85
isCon H280 PA	/ PA	5674887	5408 04 9		45						
isCon H280 VA	/ V2A	5674870	5408 04 7		45	RB90 610 VA4301	100/ V2A	6820870	7134 12 2		85
						RB90 620 VA4301	200/ V2A	6820931	7134 13 0		85
isCon PAE	/ V2A	5674719	5408 03 6		44	RB90 630 VA4301	300/ V2A	6820993	7134 13 8		85
isCon stripper		5674634	5408 00 9		44	RBU 90 640VA4301	400/ V2A	6254712	7134 23 1		85
ISO-A-500	500/ AI	5542773	5408 80 6		41	RBU 90 650VA4301	500/ V2A	6254774	7134 25 8		85
ISO-A-800	800/ AI	5542834	5408 81 4		41	RBU 90 660VA4301	600/ V2A	6254835	7134 26 6		85
K12 1818 VA4301	/ V2A	6013036	6016 42 1		81	RD 10	/ St / FT	5381617	5021 10 3	price/100	72
						RD 10-ALU	/ AI	5381976	5021 30 8		40
KS GR VA4310	/ V2A	5694625	6062 28 2	price/100	79	RD 10-V2A	/ V2A	5680567	5021 23 9		40
						RD 10-V4A	/ V4A	5680581	5021 64 7		72
KS KR VA4310	/ V2A	5694618	6062 28 0		84	RD 10-V4A	/ V4A	5680581	5021 64 7		40
						RD 8-ALU	/ AI	5381914	5021 28 6		40
KS-S DE		5448259	7205 42 5	/pc.		RD 8-ALU-T	/ AI	5901273	5021 29 4		40
KS-S DE		5448259	7205 42 5			RD 8-V2A	/ V2A	5680529	5021 23 5		40
KS-S DE		5448259	7205 42 5			RD 8-V4A	/ V4A	5680574	5021 64 4		40
KVM		5577768	2363 01 0		109	RGV 60 VA4301	60/ V2A	6230839	7082 25 8	/pc.	85
KVM-M		5686354	2363 01 5	/VPE	109	RKSM 610 VA4301	100 0,75/ V2A	5706083	6047 61 3	/m	83
				/pc.		RKSM 615 VA4301	150 0,75/ V2A	5706120	6047 63 2		83
						RKSM 620 VA4301	200 0,75/ V2A	5706144	6047 64 0		83
KVM-P		5687771	2363 01 9		109	RKSM 630 VA4301	300 0,75/ V2A	5706182	6047 65 6		83



# Type listing

Structure of the GTIN: Country code **40** Manufacturer code **1219** Individual GTIN **5647589**

Type	Dimensions/Colour/Div.	GTIN	Art. no.	Price	Page	Type	Dimensions/Colour/Div.	GTIN	Art. no.	Price	Page
RKSM 640 VA4301	400 0,9/ V2A	5706205	6047 69 1	/m	83	SQ-17 LGR	17-19 16-20 / PA	5595533	2146 11 8	price/100	102
RKSM 650 VA4301	500 0,9/ V2A	5706243	6047 72 1		83						
RKSM 660 VA4301	600 0,9/ V2A	5706267	6047 73 7		83	SQ-20 LGR	20-23 19,5-23,5 / PA	5595656	2146 13 4		102
						SQ-20 SW	19,5-23,5 / PP	5655367	2146 16 4		45
						SQ-25 LGR	25-28 24-28 / PA	5595717	2146 20 7		102
RLVK 60 VA4301	60/ V2A	6066018	6067 65 4	/pc.	84	SQ-28 LGR	28-32 27,5-32 / PA	5595779	2146 21 5		102
RWVL 60 VA4301	60/ V2A	6066070	6067 66 2		85	SQ-32 LGR	32-35 31,2-35,8 / PA	5595830	2146 25 8		102
						SQ-36 LGR	35-40 35-40,1 / PA	5204275	2146 29 0		102
S16 VA	16 3000/ V2A	5622246	2047 65 0	price/100	106	SQ-40 LGR	40-44 39,3-44,5 / PA	5595892	2146 32 0		102
						SQ-47 LGR	45-50 44-50 / PA	5204398	2146 36 3		102
S20 VA	20 3000/ V2A	5622253	2047 65 1		106	SQ-51 LGR	50-54 48-55 / PA	5595953	2146 44 4		102
						SQ-59 LGR	59-65 58,5-65 / PA	5204510	2146 48 7		102
S25 VA	25 3000/ V2A	5622260	2047 65 2		106						
S32 VA	32 3000/ V2A	5622291	2047 65 3		106	SV16 VA	18,6 50/ V2A	5622406	2047 66 5		106
						SV20 VA	22,6 54/ V2A	5622413	2047 66 6		106
S40 VA	40 3000/ V2A	5622307	2047 65 4		106	SV25 VA	28,3 64/ V2A	5622420	2047 66 8		106
SB16 VA	16 178/ V2A	5622543	2047 68 2	price/100	106	SV32 VA	35 74/ V2A	5622437	2047 66 9		106
SB20 VA	20 183/ V2A	5622550	2047 68 3		106	SV40 VA	44 95/ V2A	5622444	2047 67 0		106
SB25 VA	25 207/ V2A	5622567	2047 68 4		106	SVM16 VA	M16x1,5 32/ V2A	5622475	2047 67 3		106
SB32 VA	32 245/ V2A	5622574	2047 68 5		106	SVM20 VA	M20x1,5 40/ V2A	5622482	2047 67 4		106
						SVM25 VA	M25x1,5 40/ V2A	5622499	2047 67 6		106
SB40 VA	40 288/ V2A	5622581	2047 68 6		106	SVM32 VA	M32x1,5 44/ V2A	5622505	2047 67 7		106
SBM16 VA	M16x1,5 178/ V2A	5622611	2047 69 0		106	SVM40 VA	M40x1,5 50/ V2A	5622512	2047 67 8		106
SBM20 VA	M20x1,5 183/ V2A	5622628	2047 69 2		106						
SBM25 VA	M25x1,5 207/ V2A	5622635	2047 69 3		106	T 100	/ PP	5246794	2007 07 7		108
						T 100 F	/ PP	5286547	2007 34 7		108
SBM32 VA	M32x1,5 245/ V2A	5622642	2047 69 4		106	T 100 KL	/ PP	5441212	2007 43 6		108
						T 100 RO-LGR	/ PP	5303282	2007 64 4		108
SBM40 VA	M40x1,5 288/ V2A	5622659	2047 69 5		106	T 100 RW	/ PP	5286677	2007 53 3		108
						T 100 UV RW	/ PP	5441106	2007 41 4		108
SC-TELE 4-C-G		5834793	5081 68 8	/pc.	51	T 60	/ PP	5246787	2007 06 1		108
						T 60 F	/ PP	5286509	2007 33 9		108
						T 60 KL	/ PP	5441182	2007 43 4		108
						T 60 OE	/ PP	5246848	2007 23 9		108
SD-Fix		5670735	5403 33 5		41	T 60 RO-LGR	/ PP	5303275	2007 63 8		108
						T 60 RW	/ PP	5286660	2007 52 5		108
						T 60 UV RW	/ PP	5441090	2007 41 2		108
SLL 620 CPS 4 FT	200 6000/ St / FT	5434047	6010 63 0	/m	87						
SLL 630 CPS 4 FT	300 6000/ St / FT	5434085	6010 63 2		87	TrayFix		5738428	5403 10 0		82
SLL 640 CPS 4 FT	400 6000/ St / FT	5434092	6010 63 4		87						
SLL 650 CPS 4 FT	500 6000/ St / FT	5434108	6010 63 6		87						
SLL 660 CPS 4 FT	600 6000/ St / FT	5434146	6010 63 8		87						
SLM 50 C40 2 FT	200 3000/ ST / FT	6146116	6010 46 6		87	TSG 30 DD	30 3000/ St / DD	5694663	6062 31 4	/m	79
SLM 50 C40 3 FT	300 3000/ ST / FT	6146178	6010 47 4		87	TSG 30 VA4301	30 3000/ V2A	5694502	6062 05 2		79
SLM 50 C40 4 FT	400 3000/ ST / FT	6146239	6010 48 2		87	TSG 60 VA4301	60 3000/ V2A	5694557	6062 08 4		84
SLM 50 C40 5 FT	500 3000/ ST / FT	6146291	6010 49 0		87	TSG 85 DD	85 3000/ St / DD	5694694	6062 33 1		79
SLM 50 C40 6 FT	600 3000/ ST / FT	6168859	6010 50 4		87	TSG 85 VA4301	85 3000/ V2A	5694601	6062 17 3		79
SM16 VA	M16x1,5 3000/ V2A	5622338	2047 65 7	price/100	105	TSGV VA4310	/ V2A	5694724	6067 97 0	/pc.	79
						TSGV VA4310	/ V2A	5694724	6067 97 0		84
SM20 VA	M20x1,5 3000/ V2A	5622345	2047 65 8		105	US 3 K 100 FT	1000 2/ St / FT	6225132	6342 36 8		88
SM25 VA	M25x1,5 3000/ V2A	5622352	2047 66 0		105	US 3 K 100VA4301	1000 2/ V2A	5705437	6342 41 7		89
SM32 VA	M32x1,5 3000/ V2A	5622369	2047 66 1		105	US 3 K 110 FT	1100 2/ St / FT	6225378	6342 37 0		88
						US 3 K 120 FT	1200 2/ St / FT	6225439	6342 37 2		88
SM40 VA	M40x1,5 3000/ V2A	5622376	2047 66 2		105	US 3 K 20 FT	200 2/ St / FT	6224470	6342 35 1		88
						US 3 K 20VA4301	200 2/ V2A	5705352	6342 40 1		89
SQ 1632	16	5028154	2153 57 2	/pc.	105	US 3 K 30 FT	300 2/ St / FT	6224531	6342 35 3		88
						US 3 K 30VA4301	300 2/ V2A	5705369	6342 40 3		89
SQ M6	M6 15/ PC	5016069	2146 50 9	price/100	102	US 3 K 40 FT	400 2/ St / FT	6224593	6342 35 5		88
SQ M8	M8 15/ PC	5016113	2146 51 1		102	US 3 K 40VA4301	400 2/ V2A	5705376	6342 40 5		89
SQ-10 LGR	10 9,5-12 / PA	5595359	2146 05 3		102						
SQ-12 LGR	12-14 11,5-15 / PA	5595410	2146 06 1		102	US 3 K 50 FT	500 2/ St / FT	6224654	6342 35 7		88
SQ-15 LGR	15-16 14-16,5 / PA	5595472	2146 09 6		102						

12 LPA Lösungskatalog Photovoltaik\_2011\_Neu/en / 25/08/2011 (LLExpert\_01327)



Type	Dimensions/Colour/Div.	GTIN	Art. no.	Price	Page	Type	Dimensions/Colour/Div.	GTIN	Art. no.	Price	Page
US 3 K 50VA4301	5002/ V2A	5705383	6342 40 7	/pc.	89	VG-BC DC-MSFS600	600	5835646	5088 69 5	/pc.	59
						VG-BC DC-MSFS900	900	5835653	5088 69 6		59
US 3 K 60 FT	6002/ St / FT	6224715	6342 35 9		88	VG-BC DCPH-MS600	600	5613725	5088 69 3		58
						VG-BC DCPH-MS900	900	5613718	5088 69 2		58
US 3 K 60VA4301	6002/ V2A	5705390	6342 40 9		89	VG-BC DCPH-Y600	600	5709008	5088 67 6		60
						VG-BC DCPH-Y900	900	5709015	5088 67 8		60
US 3 K 70 FT	7002/ St / FT	6224777	6342 36 2		88						
						VG-C DCPH1000-21	1000	5829461	5088 64 6		57
US 3 K 70VA4301	7002/ V2A	5705406	6342 41 1		89	VG-C DCPH1000-31	1000	5829478	5088 64 8		57
						VG-C DCPH1000-4K	1000	5780700	5088 65 0		56
US 3 K 80 FT	8002/ St / FT	6225019	6342 36 4		88	VG-C DCPH1000-4S	1000	5780717	5088 65 1		56
						VG-C DCPH1000-6S	1000	5780724	5088 65 2		56
US 3 K 80VA4301	8002/ V2A	5705413	6342 41 3		89	VG-C DC-PH-MS		5371090	5088 69 4		58
						VG-C DCPH-MS1000	1000	5613701	5088 69 1		58
US 3 K 90 FT	9002/ St / FT	6225071	6342 36 6		88	VG-C DC-PH-Y		5473206	5088 69 9		61
						VG-C DCPH-Y1000	1000	5708964	5088 67 2		60
US 3 K 90VA4301	9002/ V2A	5705420	6342 41 5		89	VG-C DCPH-Y600	600	5708957	5088 67 0		60
US 3 KS OR	Pastel orange/ PE	5668039	6338 45 8		89						
						V-TEC RA SET		5034278	3010 27 5		111
US 5 K 100 FT	1000 2,5/ St / FT	6536290	6341 61 6		90					price/100	
						V-TEC VM12 LGR	M12 x 1,5Light grey/ PA	5533177	2022 86 2		111
US 5 K 100VA4301	1000 2,5/ V2A	6350711	6341 39 0		91	V-TEC VM12 SW	M12 x 1,5Black/ PA	5534013	2022 88 3		111
						V-TEC VM16 LGR	M16 x 1,5Light grey/ PA	5533238	2022 86 4		111
US 5 K 110 FT	1100 2,5/ St / FT	6536238	6341 62 4		90	V-TEC VM16 SW	M16 x 1,5Black/ PA	5535638	2022 88 5		111
US 5 K 120 FT	1200 2,5/ St / FT	6536177	6341 63 2		90	V-TEC VM20 LGR	M20 x 1,5Light grey/ PA	5533658	2022 86 6		111
						V-TEC VM20 SW	M20 x 1,5Black/ PA	5535690	2022 88 7		111
US 5 K 120VA4301	1200 2,5/ V2A	6350834	6341 39 8		91	V-TEC VM25 LGR	M25 x 1,5Light grey/ PA	5533719	2022 86 8		111
						V-TEC VM25 SW	M25 x 1,5Black/ PA	5535751	2022 88 9		111
US 5 K 20 FT	200 2,5/ St / FT	6536771	6341 52 7		90	V-TEC VM32 LGR	M32 x 1,5Light grey/ PA	5533771	2022 87 0		111
						V-TEC VM32 SW	M32 x 1,5Black/ PA	5538219	2022 89 1		111
US 5 K 20 VA4301	200 2,5/ V2A	6477135	6341 35 8		91	V-TEC VM40 LGR	M40 x 1,5Light grey/ PA	5533832	2022 87 2		111
						V-TEC VM40 SW	M40 x 1,5Black/ PA	5538332	2022 89 3		111
US 5 K 30 FT	300 2,5/ St / FT	6536719	6341 53 5		90	V-TEC VM50 LGR	M50 x 1,5Light grey/ PA	5533894	2022 87 4		111
						V-TEC VM50 SW	M50 x 1,5Black/ PA	5538455	2022 89 5		111
US 5 K 30 VA4301	300 2,5/ V2A	6644230	6341 36 2		91	V-TEC VM63 LGR	M63 x 1,5Light grey/ PA	5533955	2022 87 6		111
						V-TEC VM63 SW	M63 x 1,5Black/ PA	5538516	2022 89 7		111
US 5 K 40 FT	400 2,5/ St / FT	6536658	6341 54 3		90						
US 5 K 40 VA4301	400 2,5/ V2A	6350292	6341 36 6		91						
US 5 K 50 FT	500 2,5/ St / FT	6536597	6341 55 1		90	WDK-H30045	Pure white 2000/ PC/ABS	5237402	6175 00 8	/m	95
						WDK-H40060	Pure white 2000/ PC/ABS	5237419	6175 01 4		96
US 5 K 50 VA4301	500 2,5/ V2A	6350414	6341 37 0		91	WDK-H40061	Pure white 2000/ PC/ABS	5237426	6175 02 0		97
						WDK-H60090	Pure white 2000/ PC/ABS	5237457	6175 02 6		98
US 5 K 60 FT	600 2,5/ St / FT	6536535	6341 57 8		90	WDK-H60110	Pure white 2000/ PC/ABS	5237464	6175 03 2		99
US 5 K 70 FT	700 2,5/ St / FT	6536474	6341 58 6		90	WDK-H60150	Pure white 2000/ PC/ABS	5237471	6175 03 8		100
US 5 K 80 FT	800 2,5/ St / FT	6536412	6341 59 4		90						
US 5 K 90 FT	900 2,5/ St / FT	6536351	6341 60 8		90						
US 5 KS OR	Pastel orange/ PE	5668046	6338 46 2		91	WDK-HA30045	Pure white 60/ PC/ABS	5237549	6175 10 3	/pc.	95
						WDK-HA40060	Pure white 85/ PC/ABS	5237556	6175 10 9		96
						WDK-HA40061	Pure white 85/ PC/ABS	5237563	6175 11 5		97
						WDK-HA60090	Pure white 130/ PC/ABS	5237570	6175 12 1		98
V20-C 0-300PV	300	5708902	5099 61 1		62	WDK-HA60110	Pure white 130/ PC/ABS	5237587	6175 12 7		99
V20-C 0-500PV	500	5708933	5099 70 8		62	WDK-HA60150	Pure white 130/ PC/ABS	5237594	6175 13 3		100
V20-C 1+NPE+FS		5382911	5094 76 0		50	WDK-HE30045	Pure white 45/ PC/ABS	5237631	6175 15 6		95
V20-C 1+NPE-280		5382973	5094 65 0		50	WDK-HE40060	Pure white 60/ PC/ABS	5237648	6175 16 2		96
V20-C 2-PH-1000	1000	5478669	5094 61 7		55	WDK-HE40061	Pure white 60/ PC/ABS	5237655	6175 16 8		97
V20-C 2PH-600	600	5708889	5094 61 3		54	WDK-HE60090	Pure white 90/ PC/ABS	5237662	6175 17 4		98
V20-C 2PHFS-1000	1000	5709114	5094 61 5		55	WDK-HE60110	Pure white 110/ PC/ABS	5237693	6175 18 0		99
V20-C 2PHFS-600	600	5709077	5094 57 2		54	WDK-HE60150	Pure white 150/ PC/ABS	5237709	6175 18 6		100
V20-C 3+NPE+FS		5240242	5094 76 5		50	WDK-HF30045	Pure white 60/ PC/ABS	5237716	6175 20 4		95
V20-C 3+NPE-280		5240099	5094 65 6		50	WDK-HF40060	Pure white 85/ PC/ABS	5237723	6175 21 0		96
V20-C 3-PH-1000	1000	5478621	5094 60 8		55	WDK-HF40061	Pure white 85/ PC/ABS	5237730	6175 21 6		97
V20-C 3PH-600	600	5708872	5094 60 5		54	WDK-HF60090	Pure white 120/ PC/ABS	5237747	6175 22 2		98
V20-C 3PHFS-1000	1000	5648482	5094 57 4		55	WDK-HF60110	Pure white 140/ PC/ABS	5237754	6175 22 8		99
V20-C 3PHFS-600	600	5709084	5094 57 6		54	WDK-HF60150	Pure white 180/ PC/ABS	5237778	6175 23 4		100
V20-C U-2 PH		5464457	5096 63 7		63	WDK-HI30045	Pure white 60/ PC/ABS	5237488	6175 05 1		95
V20-C U-2 PH+FS		5464464	5096 63 9		63	WDK-HI40060	Pure white 85/ PC/ABS	5237495	6175 05 7		96
V20-C U-3PH-Y		5299455	5096 64 7		63	WDK-HI40061	Pure white 85/ PC/ABS	5237501	6175 06 3		97
V20-C U-3PH-Y-FS		5648499	5096 64 6		63	WDK-HI60090	Pure white 130/ PC/ABS	5237518	6175 06 9		98
						WDK-HI60110	Pure white 130/ PC/ABS	5237525	6175 07 5		99
V25-B+C 0-450PV	450	5708896	5097 06 5		62	WDK-HI60150	Pure white 130/ PC/ABS	5237532	6175 08 1		100
V25-B+C 2-PH900	900	5478690	5097 45 7		53	WDK-HT30045	Pure white 130/ PC/ABS	5237785	6175 25 5		95
V25-B+C 2PHFS900	900	5709138	5097 45 8		53	WDK-HT40060	Pure white 170/ PC/ABS	5237815	6175 26 1		96
V25-B+C 3-PH900	900	5478683	5097 44 7		53	WDK-HT40061	Pure white 170/ PC/ABS	5237822	6175 26 7		97
V25-B+C 3PHFS900	900	5709121	5097 44 8		53	WDK-HT60090	Pure white 170/ PC/ABS	5237839	6175 27 3		98
						WDK-HT60110	Pure white 190/ PC/ABS	5237846	6175 27 9		99
V50-B+C 0-300PV	300	5708841	5093 72 6		62	WDK-HT60150	Pure white 250/ PC/ABS	5237877	6175 28 5		100
V50-B+C 1+NPE		5688426	5093 65 3		49						
V50-B+C 1+NPE+FS		5688433	5093 66 1		49						
V50-B+C 2-PH600	600	5478553	5093 62 8		52						
V50-B+C 2PHFS600	600	5709060	5093 62 9		52						
V50-B+C 3+NPE		5425120	5093 65 4		49						
V50-B+C 3+NPE+FS		5425137	5093 66 2		49						
V50-B+C 3-PH600	600	5478546	5093 62 3		52						
V50-B+C 3PHFS600	600	5709022	5093 62 5		52						



**Terms and conditions of sale and delivery**  
**of OBO BETTERMANN GmbH & Co. KG, OBO BETTERMANN Projekt und Systemtechnik GmbH**  
**and OBO Befestigungselemente GmbH, Menden.**

1. All our supplies and services shall be governed exclusively by the following terms and conditions, including our additional terms and conditions for cable tray business transactions. Any terms and conditions of business and purchasing of the customer shall be valid only if we have acknowledged them in writing. Our quotations are without engagement; they are mere invitations to submit contract offers. Any and all transactions and agreements, including those entered into by our employees and agents shall only be binding upon our written confirmation or invoicing. The foregoing provision shall also apply to any modifications of the agreed formal requirements.

2. The documents and data pertaining to the quotation, such as illustrations, brochures, drawings, dimensions, loading capacity values and weight details are approximate only, unless they are expressly stipulated to be binding.

Samples are non-binding samples for inspection. Any purchase according to sample will be subject to customary deviations and deviations resulting from normal production processes. The properties of the sample shall be no guaranteed quality of the purchase object unless expressly stated otherwise in the confirmation of order. Samples must be returned to us at the latest within four weeks in perfect condition. If they are not returned within this period in proper condition, we shall be entitled to charge the purchase price for the sample in accordance with our current price list. All information on our products, in particular the illustrations, drawings, weight, dimension and performance data included in our quotations and printed matter shall be regarded as approximate average values and shall not represent any quality guarantee.

With regard to products made according to customer drawings, samples and other instructions of the customer, we will not provide any warranty nor assume any liability for the due and proper functioning of the product or for any other defects if and to the extent they are based upon the customer's specifications. The customer shall indemnify us from any third party claims, including claims for product liability as may be asserted against us for damages resulting from the products unless we have caused such damages by intent or gross negligence. The customer shall warrant that the manufacture and supply of products made in accordance with his instructions will not infringe any proprietary rights of third parties. Should any proprietary rights be asserted against us, we shall be entitled, without any legal review of the third party claims, to withdraw from the contract after hearing the customer, unless the third party withdraws the claims asserted against us under its proprietary rights within eight days by written declaration. The customer shall compensate us for any damage sustained as a result of the assertion of proprietary rights. In case of withdrawal, the work we have carried out so far shall be remunerated. Further rights under the statutory provisions shall not be affected thereby.

Any moulds, tools and design data produced by us for the execution of the order shall be our exclusive property. Unless expressly agreed otherwise, the customer shall not have any claims thereto, even if he has contributed to the costs of producing any such moulds, tools and design data.

3. The packing, shipping route and means of transportation shall be left to our discretion in the absence of any other agreements. They shall be charged at their cost price. We will take back undamaged cases, when being returned carriage paid, at 2/3 of the amount invoiced. The one-way or pool pallets used for transport shall be either exchanged upon taking delivery or returned. The smallest packing units stocked and listed may not be broken up for rationalisation reasons. In case of orders for different quantities, the nearest packing unit will be supplied.

We reserve the right to deviate from the agreed delivery quantity, in particular in the case of custom-made products, to a customary extent or in conformity with national or international standards. In case of a demand for adhering to a precise quantity, an express reference is necessary and subject to confirmation.

Master and call orders shall oblige the customer to accept the total quantity on which the master/call order is based. Where no particular call orders are specified in the contract, the total quantity of the master call order must be called within twelve months. If the customer fails to adhere to call deadlines, we shall be entitled to deliver and charge the total quantity in full after four weeks from written notice with reference to the consequences of any failure to call. Our rights arising from any default of the customer shall not be affected thereby.

4. Unless otherwise agreed, our prices are quoted ex works and do not include packing and insurance. The value added tax at the rate applicable on the date of dispatch will be added to our prices. The purchaser shall ensure the correctness of his VAT identification number, which he must notify to us immediately without being asked. He shall undertake to inform both us and the competent domestic tax authority without delay of any change in his name, address and VAT identification number.

Delivery shall be franco domicile within Germany, i.e. carriage and packing prepaid, if the net order value is in excess of € 1,200. For small orders below € 100 (net excluding value added tax), we shall invoice a lower quantity surcharge of € 10 (net) per order. Upon transfer of our supplies and services to a carrier or forwarding agent, at the latest upon their leaving our warehouse or supply plant, the risk shall pass to the recipient, even in case of deliveries free place of destination.

5. Delivery periods and delivery deadlines shall be approximate only unless we have expressly stated in writing that they are binding. Delivery periods shall commence upon receipt of our confirmation of order, but not before clarification of all execution details, ex place of delivery. The customer shall only be entitled to withdraw from the contract after having granted a reasonable extension of time. We reserve the right to make partial deliveries. Claims for damages and reimbursement of expenses - for any reason whatsoever - shall be subject to the provisions set out in article 10.

In the event of any circumstances that are beyond our control within the scope of normal operating risks and obstruct or make impracticable any delivery, we shall be entitled to suspend delivery by the duration of such obstruction plus a reasonable start-up period or to withdraw from the contract for the part not yet fulfilled. The purchaser can demand a statement from us as to whether we wish to deliver within a reasonable period or withdraw. If we fail to make such a statement, the purchaser may withdraw. Our notice to the purchaser shall be deemed to be sufficient evidence that we have been prevented from delivering.

Delivery time is extended in case of such events as labour disputes, strikes and lockouts, orders from the authorities, difficulties with the procurement of materials, spoiled work or post-processing, shutdowns and staff shortage as well as shortage of means of transport, and general occurrence of unforeseen events beyond our scope of influence, by the length of duration of these events.

6. Payments shall be made upon receipt of invoice less a 3% cash discount for payment within 10 days or net after 30 days from date of invoice. Erection work and all paid labour work must be paid within 10 days without deduction of any cash discount. In case of non-cash payments, the date of the credit note will be deemed to be the date of receipt of payment. Payments received shall always be credited first against costs, then against interest and then against the earliest liability. Cheques and bills of exchange shall only be accepted as means of payment. Any payment by bill of exchange shall be subject to a prior separate and written agreement, whereby all bill costs shall be borne by the customer and no discount can be granted. The customer shall have no right to refuse performance and no right of retention - for any legal reason whatsoever - unless we have acknowledged his claim beforehand in writing or his claim has the force of law.

The customer shall only be entitled to set off claims which have the force of law, are undisputed or acknowledged by us in writing.

7. We shall retain title to the goods supplied by us until all our claims arising from our business transactions with the customer have been satisfied - current account clause - and all bills of exchange or cheques submitted for payment by the customer have been honoured.

Any treatment or processing of goods subject to our retention of title (reserved goods) shall be carried out for us as the manufacturer in accordance with § 950 BGB (German Civil Code) without any obligation on our part. If our reserved goods are to be regarded as the main item or the main item is owned by the customer, full title to the new item shall pass to us when it is created. In other cases, we shall acquire a co-ownership interest in the new item in the proportion of the sales value of our reserved goods to the other goods used for the new item at the time of processing, intermingling, joining or mixing. The customer shall take custody of our ownership or co-ownership interest free of charge; it shall be treated as reserved goods.

Before transfer of title, our goods shall be neither pledged nor assigned as collateral without our prior consent. In addition, any third party rights or pledges shall be notified to us immediately and we shall be given all details and provided all documents necessary for intervention; otherwise the customer must bear our loss. In the latter case, our total claims against the customer shall also be immediately payable.

The customer shall be entitled to sell or to use our reserved goods in the ordinary course of business subject to the condition that the relevant claims are transferred in accordance with article 8 below. This right shall lapse upon the customer's failure to promptly meet his payment obligations towards us or in the event of any cheque or bill protests or his suspension of payments. In such cases, we shall be entitled to take back the goods provisionally at

the customer's expense and to sell them at our duly exercised discretion after a corresponding reminder has been sent to the customer. We will then pass the due amount to the customer's credit.

8. If our goods are sold before payment of our claim, the customer shall be obliged to retain our title against his purchaser until the goods have been paid for in full by the purchaser. The claim arising against the purchaser from such resale as well as any other ancillary rights or security interests of the customer resulting from the sale and any claims for compensation in case of damage to or destruction of our reserved property, including the relevant insurance sum shall hereby be assigned to us. We hereby accept this assignment. Where our co-ownership interest is sold, the relevant claims shall be assigned in the amount corresponding to the value of our interest.

The customer shall, at our request, inform us of his purchasers, notify them of the assignment made and provide us with any and all documents required to assert our rights.

As long as the customer meets his contractual obligations without delay, he shall be authorised to collect the claims assigned. He shall keep the amounts collected on our behalf separately and remit them to us immediately as soon and as far as our claims become due. The authorisation shall lapse in case of any cheque or bill protest of the customer or his definite suspension of payments. The customer shall bear the costs incurred for any action taken against third parties and shall advance them upon request.

If the security provided to us by the retention of title and the anticipatory assignment should exceed the claims to be secured by more than 20%, we shall, at the customer's request, release paid supplies of our choice. Upon payment of all our claims by the customer, assigned claims shall pass to the customer.

9. Any complaints for obvious defects regarding the quantity or quality of our supplies and services that are identifiable upon careful inspection shall without delay, but at the latest within the period of limitation of eight days from arrival of the goods at the address of the customer or the person appointed by him, be notified in writing to us, not to our representatives. Slight deviations in dimensions and designs within the scope of defined technical tolerances shall not give rise to any right of complaint. Any rejected goods may only be returned to us with our prior written authorisation.

In case of justified complaints within the prescribed period, we shall, at our option, take remedial action by way of subsequent performance, by rectifying the defect, supplying non-defective goods or providing a credit note for the lower value calculated.

We shall be entitled to refuse subsequent performance in accordance with the statutory provisions. If we refuse subsequent performance, if any subsequent performance remains unsuccessful or if the customer cannot be reasonably expected to accept any subsequent performance, the latter shall be entitled to withdraw from the contract in compliance with the provisions of the following sentences. The customer shall only be entitled to withdraw from the contract - where a withdrawal is not excluded by law - upon the unsuccessful expiry of a reasonable period for subsequent performance set by him, unless this period was not required under the statutory provisions (§§ 281 para. 2, 323 para. 2, 440, 441 para. 1 BGB (German Civil Code)).

In case of his withdrawal, the customer shall be liable for any deterioration, destruction or loss of use resulting from any negligence or intent on his part. Any claims for damages or reimbursement of expenses of the customer shall be subject to the provisions set out in article 10.

In the case of any fraudulent concealment of a defect or in the case of any provision of a quality guarantee for the goods sold at the time of the passing of risk within the meaning of § 444 BGB (German Civil Code) (seller's declaration that the object sold has a specific property at the time of the passing of risk and that the seller, regardless of any fault on his part, intends to be answerable for any and all consequences resulting from its absence), the customer's rights shall be exclusively governed by the statutory provisions.

We shall - in addition to the statutory grounds for refusal - also be entitled to refuse subsequent performance if and as long as the customer fails to send us, at our request, the rejected goods or a sample thereof; the customer shall have no right of withdrawal for any such refusal. We may further refuse any subsequent performance if the goods concerned have been altered or modified without our consent unless the customer can prove that the defect was not caused by such alteration or modification.

The limitation period for any claims arising from defects shall be one year; in the case of goods which have been used in accordance with their intended purpose for a building and have caused its defectiveness, the limitation period shall be two years. The provisions of §§ 478, 479 BGB (German Civil Code) on recourse in the chain of suppliers shall not be affected thereby.

10. In the case of a pre-contractual, contractual or non-contractual breach of duty, including unsatisfactory delivery, tortious conduct and producer's liability, we shall only be liable for compensatory damages and reimbursement of expenses - subject to further contractual or statutory liability requirements - in the case of intent, gross negligence or slightly negligent breach of a material contractual duty (contractual duty the infringement of which jeopardises the fulfilment of the object of the contract). However - except in the case of intent - our liability shall be limited to the typical contractual damage that was foreseeable at the time the contract was entered into. The purchaser shall not be permitted to make a claim for expenses incurred in vain.

Except for any breach of material duties, our liability for slight negligence shall be excluded, but in any case be limited to the amount of the purchase price.

Any claim asserted by the customer or a third party for payment of a contractual penalty shall be excluded.

With regard to damages caused by delay, we shall only be liable for slight negligence up to the amount of 5% of the purchase price agreed with us.

The exclusions and limitations of liability set forth above shall not apply in the event that a guarantee is given with respect to the quality of the object sold within the meaning of § 444 BGB (German Civil Code) if a defect is fraudulently concealed or in the event of injury to life, physical injury or injury to health, or strict liability under the German Product Liability Act.

Any and all claims for damages against us, for any legal reason whatsoever, shall become statute-barred at the latest after one year from delivery of the goods to the customer, in the case of tortious liability from the time of knowledge, or grossly negligent ignorance, of the circumstances giving rise to the claim and the person liable to pay damages. This provision shall not apply in the case of liability for intent and in the event that a guarantee is given for the quality of the object sold, in the case of fraudulent concealment of a defect or in the event of injury to life, physical injury or injury to health, or strict liability under the German Product Liability Act. Any shorter limitation periods shall take precedence.

11. We shall be entitled to process and store any customer data obtained with regard to or in connection with the business relationship in accordance with the German Federal Data Protection Act, irrespective of whether such data is provided by the purchaser himself or by any third parties.

12. Place of performance for delivery and payment is Menden/Sauerland. The court of competent jurisdiction for any and all disputes, including disputes with regard to bills of exchange and cheques, is the Local Court (Amtsgericht) of Menden or, at our option, the District Court (Landgericht) of Arnsberg, irrespective of the value of the object in dispute. We shall, however, also be entitled to take legal proceedings against the customer at the place of his registered office.

German law shall be exclusively applicable. The application of international purchase laws is hereby excluded.

Should, for any reason whatsoever, individual provisions of our terms and conditions of sale and delivery be invalid, the validity and binding nature of the other provisions shall not be affected thereby. The customer agrees, that the invalid provision shall be replaced by a valid provision that comes as close as possible to the economic meaning of the invalid provision.

13. The prices of products made of brass and copper are subject to certain fluctuations that are based on the relevant DEL listings. The prices of our brass articles are based on a DEL listing of € 150 for Ms 58, those of our copper products on a DEL value for electrolyte copper of € 200.

In case of any increase or reduction in these prices by more than € 15, a five per cent surcharge or deduction shall be made for each 15 points. The calculation of any such surcharges or deductions shall be based on the DEL listing of the date of our receipt of the order.

Valid from August 2004

[www.obo-betterman.com](http://www.obo-betterman.com)



**OBO BETTERMANN GmbH & Co. KG**

PO Box 1120  
58694 Menden

**Customer Service Germany**

Tel.: +49 (0)2373 89-1500  
Fax: +49 (0)2373 89-7777  
E-mail: [info@obo.de](mailto:info@obo.de)

[www.obo-betterman.com](http://www.obo-betterman.com)